

MOSAIC

MODULAR SAFETY INTEGRATED CONTROLLER

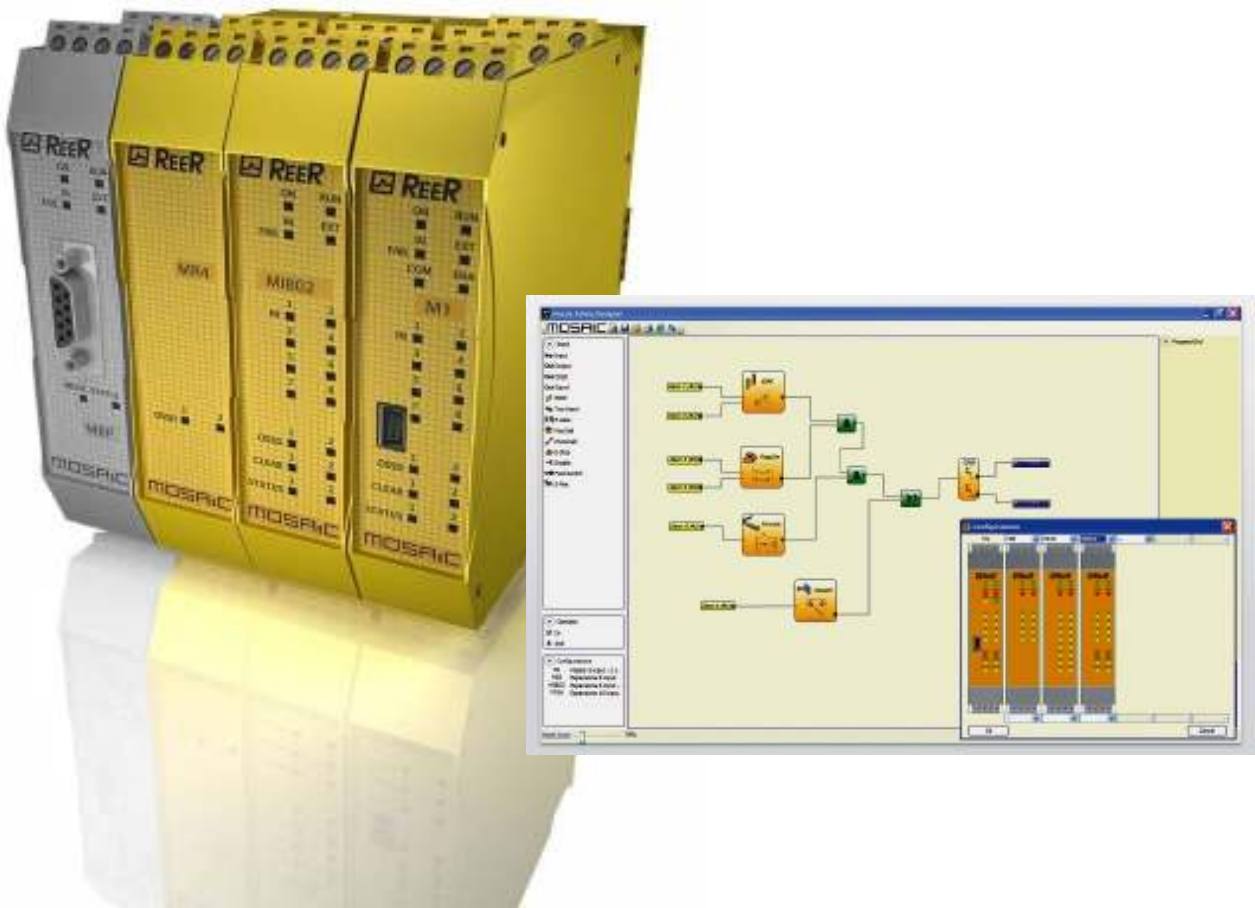

(Copy of the original instructions)



32 via Carcano
10153 Torino Italia
www.reer.it



Dichiarazione CE di conformità
EC declaration of conformity

Torino, 15/06/2010

REER SpA
via Carcano 32
10153 – Torino
Italy

dichiara che il controllore integrato MOSAIC costituisce un dispositivo di sicurezza realizzato in conformità alle seguenti Direttive Europee:

declares that the integrated controller MOSAIC is a safety device complying with the following European Directives:

2006/42/CE	"Direttiva Macchine" "Machine Directive"
2004/108/CE	"Direttiva Compatibilità Elettromagnetica" "Electromagnetic Compatibility Directive"
2006/95/CE	"Direttiva Bassa Tensione" "Low Voltage Directive"

ed è conforme alle seguenti norme:
and complies with the following standards:

CEI EN 61131-2 (07/2007)	Controllori programmabili - Parte 2: Specifiche e prove delle apparecchiature. <i>Programmable controllers - Part 2. Equipment requirements and tests.</i>
ISO 13849-1 (06/2008)	Sicurezza del macchinario: Parti dei sistemi di comando legate alla sicurezza. Parte 1: Principi generali per la progettazione. <i>Safety of machinery:- Safety-related parts of control systems - Part 1: General principles for design.</i>
EN 61496-1 (11/2005)	Sicurezza del macchinario: Dispositivi Elettrosensibili di protezione, Parte 1: Requisiti generali e tests. <i>Safety of machinery : Electro sensitive protective equipment, Part 1: General requirements and tests.</i>
IEC 61508-1 (04/2010)	Sicurezza funzionale di impianti elettrici/elettronici/programmabili legati alla sicurezza: Requisiti generali. <i>Functional safety of electrical/electronic programmable electronic safety related systems: General requirements.</i>
IEC 61508-2 (04/2010)	Sicurezza funzionale di impianti elettrici/elettronici/programmabili legati alla sicurezza: Requisiti per impianti elettrici/elettronici/programmabili legati alla sicurezza. <i>Functional safety of electrical/electronic/programmable electronic safety related systems: Requirements for electrical/electronic/programmable electronic safety-related systems.</i>
IEC 61508-3 (04/2010)	Sicurezza funzionale di impianti elettrici/elettronici/programmabili legati alla sicurezza: Requisiti Software. <i>Functional safety of electrical/electronic programmable electronic safety related systems: Software requirements.</i>
IEC 61784-3 (12/2007)	Reti di comunicazione industriali - Profili - Parte 3: Sicurezza funzionale dei bus di campo - Norme generali e profilo definizioni. <i>Industrial communication networks - Profiles - Part 3: Functional safety fieldbuses - General rules and profile definitions.</i>
IEC 62061 (01/2005)	Sicurezza del macchinario. Sicurezza funzionale dei sistemi di comando e controllo elettrici, elettronici e programmabili correlati alla sicurezza. <i>Safety of machinery - Functional safety of safety-related electrical, electronic and programmable electronic control systems.</i>

raggiungendo il livello di sicurezza pari a: SIL 3 / SILCL 3 / PL e/ Cat. 4 / Tipo 4 (v. standard corrispondenti)
reaching a safety level corresponding to : SIL 3 / SILCL 3 / PL e / Cat. 4 / Type 4 (see related standards)

ed è identico all'esemplare esaminato ed approvato con esame di tipo CE da:
and is identical to the specimen examined and approved with a CE - type approval by:
TÜV SÜD Rail GmbH – Ridlerstrasse 65 – D-80339 – Muenchen – Germany

Carlo Pautasso
Direttore Tecnico
Technical Director

Simone Scaravelli
Amministratore Delegato
Managing director

MODULAR SAFETY INTEGRATED CONTROLLER

CONTENTS

INTRODUCTION	6
Contents of this handbook	6
Important safety instructions	6
Abbreviations and symbols	7
Applicable standards	7
OVERVIEW	8
PRODUCT COMPOSITION	9
INSTALLATION	10
Mechanical fastening	10
Calculation of safety distance of an ESPE connected to MOSAIC	11
Electrical connections	11
Instructions concerning connection cables.	12
USB input	12
MOSAIC Configuration Memory (MCM)	13
MULTIPLE LOAD function	13
RESTORE function	13
EXAMPLE OF CONNECTION OF MOSAIC TO THE MACHINE CONTROL SYSTEM	17
CHECKLIST AFTER INSTALLATION	17
OPERATING DIAGRAM	18
SIGNALS	19
INPUTS	19
MASTER ENABLE	19
NODE SEL	19
RESTART_FBK	20
OUTPUTS	21
OUT STATUS	21
OUT TEST	21
OSSD (M1, MI8O2)	21
OSSD (MO2, MO4)	21
SAFETY RELAYS (MR2, MR4)	22
Characteristics of the output circuit	22
MR2/MR4 internal contacts diagram	22
Example of MR2 module connection with static OSSD outputs of a module M1	23
.....	23
Switching operation timing diagram	23
TECHNICAL FEATURES	24
GENERAL SYSTEM CHARACTERISTICS	24
Safety level parameters	24
General data	24
Enclosure	25
M1 module	25
MI8O2 module	25
MI8 - MI16 modules	26
MO2 - MO4 modules	26
MR2 - MR4 modules	26
MECHANICAL DIMENSIONS	27
SIGNALS	28

Master M1 (Figure 10)	28
MI8O2 (Figure 11)	29
MI8 (Figure 12).....	30
MI16 (Figure 13).....	31
MO2 (Figure 14)	32
MO4 (Figure 15)	33
MR2 (Figure 16) / MR4 (Figure 17).....	34
TROUBLESHOOTING	35
Master M1 (Figure 18)	35
MI8O2 (Figure 19)	36
MI8 (Figure 20).....	37
MI16 (Figure 21).....	38
MO2 / MO4 (Figure 22)	39
MOSAIC SAFETY DESIGNER SOFTWARE	40
Installing the software	40
PC HARDWARE requirements	40
PC SOFTWARE requirements	40
How to install MSD	40
Fundamentals.....	41
Standard tool bar	42
Create a new project (configure the MOSAIC system).....	43
EDIT CONFIGURATION (composition of the various modules).....	44
Change user parameters	44
OBJECTS - OPERATOR - CONFIGURATION tool bars.....	45
Creating the diagram (Figure 16).....	46
Example of a project	47
Project validation	47
Project report.....	47
Connect to Mosaic.....	48
Sending the configuration to the MOSAIC.....	48
Configuration LOG	48
Upload system configuration.....	49
Disconnecting System	49
MONITOR (I/O status in real time - textual)	49
MONITOR (I/O status in real time - textual - graphic).....	50
Password protection.....	51
Level 1 password	51
Level 2 password	51
Password Change.....	51
TESTING the system	52
OBJECT FUNCTION BLOCKS	53
OUTPUT OBJECTS	53
OSSD (safety outputs).....	53
STATUS (signal output).....	53
INPUT OBJECTS	54
E-STOP (emergency stop).....	54
E-GATE (safety gate device)	55
ENABLE (enable key).....	56
ESPE (optoelectronic safety light curtain / laser scanner)	57
FOOTSWITCH (safety pedal).....	59
MOD-SEL (safety selector).....	60
PHOTOCELL (safety photocell)	60

TWO-HAND (bimanual control)	61
SENSOR	62
S-MAT (safety mat)	63
SWITCH	64
COMMENTS	65
TITLE.....	65
OPERATOR FUNCTION BLOCKS.....	65
LOGICAL OPERATORS	65
AND	65
NAND.....	66
NOT	66
OR.....	66
NOR	67
XOR.....	67
XNOR	67
MULTIPLEXER.....	68
MEMORY OPERATORS	68
D FLIP FLOP (max number = 8)	68
SR FLIP FLOP.....	69
USER RESTART MANUAL (max number = 8 with RESTART MONITORED)	69
USER RESTART MONITORED (max number = 8 with RESTART MANUAL)	69
COUNTER OPERATORS.....	70
COUNTER operator is a pulse counter that sets output Q to 1 (TRUE) as soon as the desired count is reached.....	70
COUNTER (max number = 8).	70
TIMER OPERATORS (max number = 8).....	70
CLOCKING.....	70
MONOSTABLE.....	71
PASSING MAKE CONTACT	72
DELAY	73
MUTING OPERATORS (max number = 4).....	74
"Concurrent" MUTING	74
MUTING "L"	75
"Sequential" MUTING	76
MUTING "T"	77
SPECIAL APPLICATIONS.....	78
Output delay with manual	78
ACCESSORIES AND SPARE PARTS.....	79
WARRANTY	80

INTRODUCTION

Contents of this handbook

This handbook describes how to use the MOSAIC programmable safety module and its expansion units ("SLAVES");







it includes:

- a description of the system
- method of installation
- connections
- signals
- troubleshooting
- use of the configuration SW

Important safety instructions

 This safety alert symbol indicates a potential **personal safety hazard**. Failure to comply with instructions bearing this symbol could pose a very serious risk to personnel.

 This symbol indicates an important instruction.

-  The MOSAIC is built to the following safety levels: SIL 3, SILCL 3, PL e, Cat. 4, Type 4 in accordance with the applicable standards.
However, the definitive SIL and PL of the application will depend on the number of safety components, their parameters and the connections that are made, as per the risk analysis.
-  Read the "Applicable Standards" section carefully.
-  Perform an in-depth risk analysis to determine the appropriate safety level for your specific application, on the basis of all the applicable standards.
-  Always test the complete system whenever new safety components are added (see the "TESTING the system" section).
-  The ambient temperature in the place where the system is installed must be compatible with the operating temperature parameters stated on the product label and in the specifications.
-  For all matters concerning safety, if necessary, contact your country's competent safety authorities or the competent trade association.

Abbreviations and symbols

MCM =	MOSAIC Configuration Memory: <i>memory chip for MOSAIC M1 (accessory)</i>
MSC =	MOSAIC Safety Communication: <i>proprietary bus for expansion units</i>
MSD =	MOSAIC Safety Designer: <i>MOSAIC configuration SW running in Windows</i>
OSSD =	Output Signal Switching Device: <i>solid state safety output</i>
MTTF_d =	Mean Time to Dangerous Failure
PL =	Performance Level
PFH_d =	Probability of a dangerous failure per Hour
SIL =	Safety Integrity Level
SILCL =	Safety Integrity Level Claim Limit
SW =	Software

Applicable standards

MOSAIC complies with the following European Directives:

- 2006/42/EC "Machinery Directive"
- 2004/108/EC "Electromagnetic Compatibility Directive"
- 2006/95/EC "Low Voltage Directive"

and is built to the following standards:

CEI EN 61131-2	Programmable controllers, part 2: Equipment requirements and tests
ISO 13489-1	Safety of machinery: Safety related parts of control systems. General principles for design
EN 61496-1	Safety of machinery: Electro-sensitive protective equipment. Part 1: General requirements and tests.
IEC 61508-1	Functional safety of electrical/electronic/programmable electronic safety-related systems: General requirements.
IEC 61508-2	Functional safety of electrical/electronic/programmable electronic safety-related systems: Requirements for electrical/electronic/programmable electronic safety-related systems.
IEC 61508-3	Functional safety of electrical/electronic/programmable electronic safety-related systems: Software requirements.
IEC 61784-3	Digital data communication for measurement and control: Functional safety fieldbuses.
IEC 62061	Safety of machinery. Functional safety of safety-related electrical, electronic and programmable electronic control systems

Table 1

OVERVIEW

MOSAIC is a modular safety controller. It consists of a master unit (**M1**), which can be configured using the MSD graphic interface, and a number of expansion units connected to the M1 via the proprietary MSC bus.

The M1 can also be used as a stand-alone device. It has 8 safety inputs and 2 independent programmable dual channel outputs.

➔ The following expansions are available: I/O expansions (**MI8O2**), input only expansions (**MI8 and MI16**), output only expansions (**MO2 and MO4**), guided contact safety relay output modules (**MR2 and MR4**) and diagnostic connections to the main fieldbuses:
MBP (PROFIBUS), **MBC** (CanOpen), **MBD** (DeviceNet).

MOSAIC is capable of monitoring the following safety sensors and commands: optoelectronic sensors (safety light curtains, scanners, safety photocells), mechanical switches, safety mats, emergency stops, two-hand controls, all managed by a single flexible and expandable device.

The system must consist of just one Master M1 and a number of electronic expansions that can range from 0 to a maximum of 7, not more than 4 of which of the same type. There is no limit to the number of relay modules that can be installed.

With 7 expansions, the system can have up to 72 inputs and 8 dual channel safety outputs. The MASTER and its SLAVE units communicate via the 5-way MSC bus (Reer proprietary bus), physically arranged on the rear panel of each unit.

The MSD software is capable of creating complex logics, using logical operators and safety functions such as muting, timer, counters, etc.

All this is performed through an easy and intuitive graphic interface.

The configuration performed on the PC is sent to the M1 via USB connection; the file resides in the M1 and can also be saved on the proprietary MCM memory chip (accessory). The configuration can therefore quickly be copied to another M1 unit.

➔ The MOSAIC system is certified to the maximum safety level envisaged by the applicable industrial safety standards (SIL 3, SILCL 3, PL e, Cat. 4).

PRODUCT COMPOSITION

The MOSAIC M1 is supplied with:

- CD-ROM containing the free MSD SW, this PDF multi-language handbook and other product literature.
- Multi-language installation sheet.

➔ NB: the rear panel MSC connector and MCM memory can be ordered separately as accessories.

The expansion units are supplied with:

- Multilingual Installation sheet.
- Rear panel MSC connector (not present in the MR2 and MR4 which are connected via terminal blocks only).

➔ NB: to install an expansion unit (excluding relays) you will need the MSC connector supplied with the unit plus another MSC for the connection to the M1. This can be ordered separately as an accessory.

INSTALLATION

Mechanical fastening

Fix the MOSAIC system units to a 35mm DIN rail as follows:

1. Connect the same number of "MSC" 5-pole rear panel connectors as the number of units to be installed.
2. Fix the train of connectors thus obtained to the Omega DIN 35mm (EN 5022) rail (hooking them at the top first).
3. Fasten the units to the rail, arranging the contacts on the base of the unit on the respective connector. Press the unit gently until you feel it snap into place.
4. To remove a unit, use a screwdriver to pull down the locking latch on the back of the unit; then lift the unit upwards and pull.

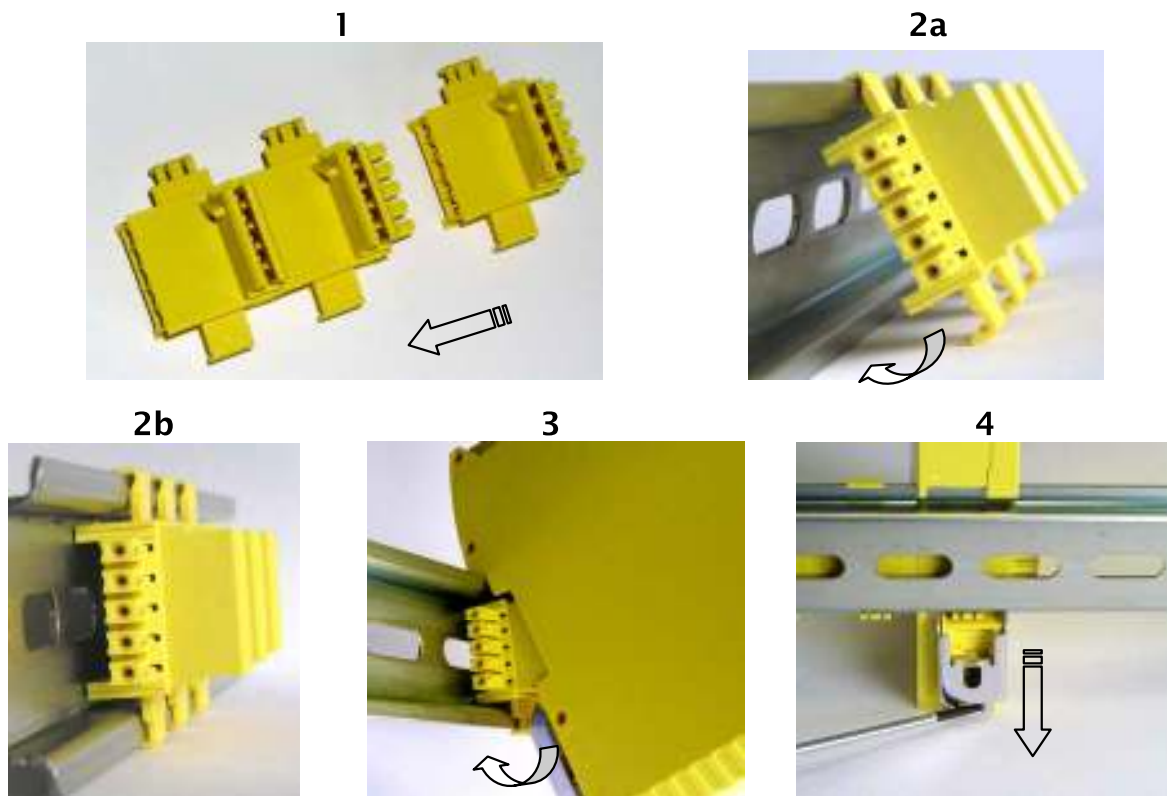

Figure 1

Calculation of safety distance of an ESPE connected to MOSAIC

Any Electro-sensitive Protective Equipment device connected to MOSAIC, must be positioned at a distance equal to or greater than the minimum safety distance S so that the dangerous point can be reached only after stopping the dangerous movement of the machine.

- The european standard:
 - ISO 13855:2010- (EN 999:2008) Safety of machinery - *Positioning of safeguards with respect to the approach speeds of parts of the human body.*¹ provides the elements to calculate the proper safety distance.
- Carefully read the installation manual of each device for specific information on the correct positioning.
- Remember that the total response time depends on:
 MOSAIC response time + ESPE response time + response time of the machine (i.e. the time taken by the machine to stop the dangerous movement from the moment in which the stop signal is transmitted).

Electrical connections

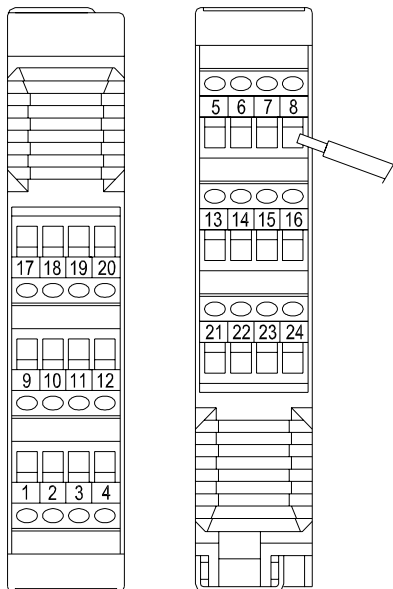

The MOSAIC system units are provided with terminal blocks for the electrical connections. Each unit can have 8, 16 or 24 terminals. Each unit also has a rear panel plug-in connector (for communication with the master and with the other expansion units).

The MR2 and MR4 are connected via terminal blocks only.

- Install safety units in an enclosure with a protection class of at least IP54.
- The supply voltage to the units must be 24Vdc $\pm 20\%$ (PELV, in compliance with the standard EN 60204-1 (Chapter 6.4)).
- Do not use the MOSAIC to supply external devices.
- The same ground connection (0VDC) must be used for all system components.

¹ "Describe the methods that designers can use to calculate the minimum safety distance from a specific dangerous point for the safety devices, particularly Electro-sensitive devices (eg. light curtains), safety-mats or pressure sensitive floors and bimanual control. It contains a rule to determine the placement of safety devices based on approach speed and the stopping time of the machine, which can reasonably be extrapolated so that it also includes the interlocking guards without guard locking."

Instructions concerning connection cables.

- ➔ Cables used for connections must be AWG26 ÷ AWG14. Cables used for connections of longer than 50m must have a cross-section of at least 1mm² (AWG16).
- ➔ We recommend the use of separate power supplies for the safety module and for other electrical power equipment (electric motors, inverters, frequency converters) or other sources of disturbance.

Connections of each single MOSAIC system unit are listed in the table below:

Master M1				
TERMINAL	SIGNAL	TYPE	DESCRIPTION	OPERATION
1	24VDC	-	24VDC power supply	-
2	MASTER_ENABLE1	Input	Master Enable 1	Input (" type B " according to EN 61131-2)
3	MASTER_ENABLE2	Input	Master Enable 2	Input (" type B " according to EN 61131-2)
4	GND	-	0VDC power supply	-
5	OSSD1_A	Output	Static output 1	PNP active high
6	OSSD1_B	Output		PNP active high
7	RESTART_FBK1	Input	Feedback/Restart 1	Input according to EN 61131-2
8	OUT_STATUS1	Output	Programmable digital output	PNP active high
9	OSSD2_A	Output	Static output 2	PNP active high
10	OSSD2_B	Output		PNP active high
11	RESTART_FBK2	Input	Feedback/Restart 2	Input according to EN 61131-2
12	OUT_STATUS2	Output	Programmable digital output	PNP active high
13	OUT_TEST1	Output	Short circuit detected output	PNP active high
14	OUT_TEST2	Output	Short circuit detected output	PNP active high
15	OUT_TEST3	Output	Short circuit detected output	PNP active high
16	OUT_TEST4	Output	Short circuit detected output	PNP active high
17	INPUT1	Input	Digital input 1	Input according to EN 61131-2
18	INPUT2	Input	Digital input 2	Input according to EN 61131-2
19	INPUT3	Input	Digital input 3	Input according to EN 61131-2
20	INPUT4	Input	Digital input 4	Input according to EN 61131-2
21	INPUT5	Input	Digital input 5	Input according to EN 61131-2
22	INPUT6	Input	Digital input 6	Input according to EN 61131-2
23	INPUT7	Input	Digital input 7	Input according to EN 61131-2
24	INPUT8	Input	Digital input 8	Input according to EN 61131-2

USB input

The MOSAIC master M1 includes a USB 2.0 connector for connection to a Personal Computer where the **MSD** (MOSAIC Safety Designer) configuration SW resides.

A USB cable of the correct size is available as an accessory (**CSU**).



Figure 2 - USB 2.0 front panel connector

TECHNICAL DATA LABEL

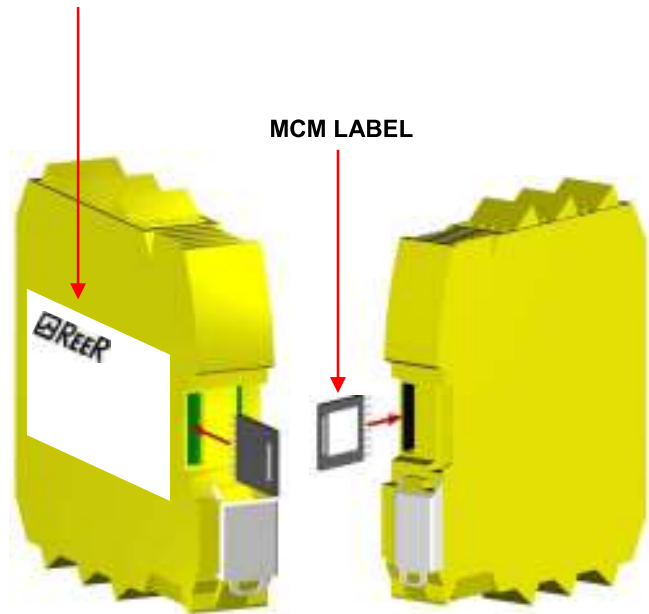

Figure 3 - MCM

MOSAIC Configuration Memory (MCM)

A backup memory, called **MCM** (optional) can be installed in the MOSAIC master M1 and used to save the SW configuration parameters.

The MCM is written **each time** a new project is sent from the PC to the M1.

➔ Always switch the M1 off before logging on to/logging off from the MCM.

Insert the card in the **slot in the rear panel of the M1** (in the direction shown in Figure 3 - MCM).

MULTIPLE LOAD function

To perform the configuration of several M1 modules without using a PC and the USB connector, you can save the desired configuration on a single MCM and then use it to download data on the modules M1 to be configured.

⚠ If the file contained in the MCM is not identical to the one contained in M1, an overwrite operation that will permanently delete the configuration data contained in M1 will be performed.
WARNING: ALL DATA PREVIOUSLY CONTAINED IN M1 WILL BE LOST.

RESTORE function

If the M1 unit is damaged, you can replace it with a new one; having already saved all the configurations on the MCM, all you need to do is insert the MCM in the new M1 and switch on the MOSAIC system, that will immediately load the backup configuration. In this way, the work interruptions will be minimized.

➔ The LOAD and RESTORE functions can be disabled via SW. (see Figure 26)

➔ In order to be used, the expansion units must be addressed at the time of installation (see the NODE SEL section).

⚠ Each time MCM is used, carefully check that the chosen configuration is the one that was planned for that particular system. Try again a fully functional test of the system composed of Mosaic plus all devices connected to it (see the TESTING the system section).

MI802				
TERMINAL	SIGNAL	TYPE	DESCRIPTION	OPERATION
1	24VDC	-	24VDC power supply	-
2	NODE_SELO	Input	Node selection	Input (" type B " according to EN 61131-2)
3	NODE_SEL1	Input		Input (" type B " according to EN 61131-2)
4	GND	-	0VDC power supply	-
5	OSSD1_A	Output	Static output 1	PNP active high
6	OSSD1_B	Output		PNP active high
7	RESTART_FBK1	Input	Feedback/Restart 1	Input according to EN 61131-2
8	OUT_STATUS1	Output	Programmable digital output	PNP active high
9	OSSD2_A	Output	Static output 2	PNP active high
10	OSSD2_B	Output		PNP active high
11	RESTART_FBK2	Input	Feedback/Restart 2	Input according to EN 61131-2
12	OUT_STATUS2	Output	Programmable digital output	PNP active high
13	OUT_TEST1	Output	Short circuit detected output	PNP active high
14	OUT_TEST2	Output	Short circuit detected output	PNP active high
15	OUT_TEST3	Output	Short circuit detected output	PNP active high
16	OUT_TEST4	Output	Short circuit detected output	PNP active high
17	INPUT1	Input	Digital input 1	Input according to EN 61131-2
18	INPUT2	Input	Digital input 2	Input according to EN 61131-2
19	INPUT3	Input	Digital input 3	Input according to EN 61131-2
20	INPUT4	Input	Digital input 4	Input according to EN 61131-2
21	INPUT5	Input	Digital input 5	Input according to EN 61131-2
22	INPUT6	Input	Digital input 6	Input according to EN 61131-2
23	INPUT7	Input	Digital input 7	Input according to EN 61131-2
24	INPUT8	Input	Digital input 8	Input according to EN 61131-2

Table 2

MI16				
TERMINAL	SIGNAL	TYPE	DESCRIPTION	OPERATION
1	24VDC	-	24VDC power supply	-
2	NODE_SELO	Input	Node selection	Input (" type B " according to EN 61131-2)
3	NODE_SEL1	Input		Input (" type B " according to EN 61131-2)
4	GND	-	0VDC power supply	-
5	INPUT1	Input	Digital input 1	Input according to EN 61131-2
6	INPUT2	Input	Digital input 2	Input according to EN 61131-2
7	INPUT3	Input	Digital input 3	Input according to EN 61131-2
8	INPUT4	Input	Digital input 4	Input according to EN 61131-2
9	OUT_TEST1	Output	Short circuit detected output	PNP active high
10	OUT_TEST2	Output	Short circuit detected output	PNP active high
11	OUT_TEST3	Output	Short circuit detected output	PNP active high
12	OUT_TEST4	Output	Short circuit detected output	PNP active high
13	INPUT5	Input	Digital input 5	Input according to EN 61131-2
14	INPUT6	Input	Digital input 6	Input according to EN 61131-2
15	INPUT7	Input	Digital input 7	Input according to EN 61131-2
16	INPUT8	Input	Digital input 8	Input according to EN 61131-2
17	INPUT9	Input	Digital input 9	Input according to EN 61131-2
18	INPUT10	Input	Digital input 10	Input according to EN 61131-2
19	INPUT11	Input	Digital input 11	Input according to EN 61131-2
20	INPUT12	Input	Digital input 12	Input according to EN 61131-2
21	INPUT13	Input	Digital input 13	Input according to EN 61131-2
22	INPUT14	Input	Digital input 14	Input according to EN 61131-2
23	INPUT15	Input	Digital input 15	Input according to EN 61131-2
24	INPUT16	Input	Digital input 16	Input according to EN 61131-2

Table 3

MI8				
TERMINAL	SIGNAL	TYPE	DESCRIPTION	OPERATION
1	24VDC	-	24VDC power supply	-
2	NODE_SELO	Input	Node selection	Input (" <i>type B</i> " according to EN 61131-2)
3	NODE_SEL1	Input		Input (" <i>type B</i> " according to EN 61131-2)
4	GND	-	0VDC power supply	-
5	INPUT1	Input	Digital input 1	Input according to EN 61131-2
6	INPUT2	Input	Digital input 2	Input according to EN 61131-2
7	INPUT3	Input	Digital input 3	Input according to EN 61131-2
8	INPUT4	Input	Digital input 4	Input according to EN 61131-2
9	OUT_TEST1	Output	Short circuit detected output	PNP active high
10	OUT_TEST2	Output	Short circuit detected output	PNP active high
11	OUT_TEST3	Output	Short circuit detected output	PNP active high
12	OUT_TEST4	Output	Short circuit detected output	PNP active high
13	INPUT5	Input	Digital input 5	Input according to EN 61131-2
14	INPUT6	Input	Digital input 6	Input according to EN 61131-2
15	INPUT7	Input	Digital input 7	Input according to EN 61131-2
16	INPUT8	Input	Digital input 8	Input according to EN 61131-2

Table 4

MO4				
TERMINAL	SIGNAL	TYPE	DESCRIPTION	OPERATION
1	24VDC	-	24VDC power supply	-
2	NODE_SELO	Input	Node selection	Input (" <i>type B</i> " according to EN 61131-2)
3	NODE_SEL1	Input		Input (" <i>type B</i> " according to EN 61131-2)
4	GND	-	0VDC power supply	-
5	OSSD1_A	Output	Static output 1	PNP active high
6	OSSD1_B	Output		PNP active high
7	RESTART_FBK1	Input	Feedback/Restart 1	Input according to EN 61131-2
8	OUT_STATUS1	Output	Programmable digital output	PNP active high
9	OSSD2_A	Output	Static output 2	PNP active high
10	OSSD2_B	Output		PNP active high
11	RESTART_FBK2	Input	Feedback/Restart 2	Input according to EN 61131-2
12	OUT_STATUS2	Output	Programmable digital output	PNP active high
13	24VDC	-	24VDC power supply	OSSD1/2 power supply
14	24VDC	-	24VDC power supply	OSSD3/4 power supply
15	GND	-	0VDC power supply	-
16	GND	-	0VDC power supply	-
17	OSSD4_A	Output	Static output 4	PNP active high
18	OSSD4_B	Output		PNP active high
19	RESTART_FBK4	Input	Feedback/Restart 4	Input according to EN 61131-2
20	OUT_STATUS4	Output	Programmable digital output	PNP active high
21	OSSD3_A	Output	Static output 3	PNP active high
22	OSSD3_B	Output		PNP active high
23	RESTART_FBK3	Input	Feedback/Restart 3	Input according to EN 61131-2
24	OUT_STATUS3	Output	Programmable digital output	PNP active high

Table 5

MO2				
TERMINAL	SIGNAL	TYPE	DESCRIPTION	OPERATION
1	24VDC	-	24VDC power supply	-
2	NODE_SELO	Input	Node selection	Input ("type B" according to EN 61131-2)
3	NODE_SEL1	Input		Input ("type B" according to EN 61131-2)
4	GND	-	0VDC power supply	-
5	OSSD1_A	Output	Static output 1	PNP active high
6	OSSD1_B	Output		PNP active high
7	RESTART_FBK1	Input	Feedback/Restart 1	Input according to EN 61131-2
8	OUT_STATUS1	Output	Condition of outputs 1A/1B	PNP active high
9	OSSD2_A	Output	Static output 2	PNP active high
10	OSSD2_B	Output		PNP active high
11	RESTART_FBK2	Input	Feedback/Restart 2	Input according to EN 61131-2
12	OUT_STATUS2	Output	Condition of outputs 2A/2B	PNP active high
13	24VDC	-	24VDC power supply	OSSD1/2 power supply
14	n.c.	-	-	-
15	GND	-	0VDC power supply	-
16	n.c.	-	-	-

Table 6

MR4				
TERMINAL	SIGNAL	TYPE	DESCRIPTION	OPERATION
1	24VDC	-	24VDC power supply	-
4	GND	-	0VDC power supply	-
5	OSSD1_A	Input	Control ZONE 1	PNP active high
6	OSSD1_B	Input		
7	FBK_K1_K2_1	Output	Feedback K1K2 ZONE 1	
9	A_NC1	Output	NC contact ZONE 1	
10	B_NC1	Output		
13	A_NO11	Output	NO1 contact ZONE 1	
14	B_NO11	Output		
15	A_NO12	Output	NO2 contact ZONE 1	
16	B_NO12	Output		
11	A_NC2	Output	NC contact ZONE 2	
12	B_NC2	Output		
17	OSSD2_A	Input	Control ZONE 2	PNP active high
18	OSSD2_B	Input		
19	FBK_K1_K2_2	Output	Feedback K1K2 ZONE 2	
21	A_NO21	Output	NO1 contact ZONE 2	
22	B_NO21	Output		
23	A_NO22	Output	NO2 contact ZONE 2	
24	B_NO22	Output		

Table 7

MR2				
TERMINAL	SIGNAL	TYPE	DESCRIPTION	OPERATION
1	24VDC	-	24VDC power supply	-
4	GND	-	0VDC power supply	-
5	OSSD1_A	Input	Control ZONE 1	PNP active high
6	OSSD1_B	Input		
7	FBK_K1_K2_1	Output	Feedback K1K2 ZONE 1	
9	A_NC1	Output	NC contact ZONE 1	
10	B_NC1	Output		
13	A_NO11	Output	NO1 contact ZONE 1	
14	B_NO11	Output		
15	A_NO12	Output	NO2 contact ZONE 1	
16	B_NO12	Output		

Table 8

EXAMPLE OF CONNECTION OF MOSAIC TO THE MACHINE CONTROL SYSTEM

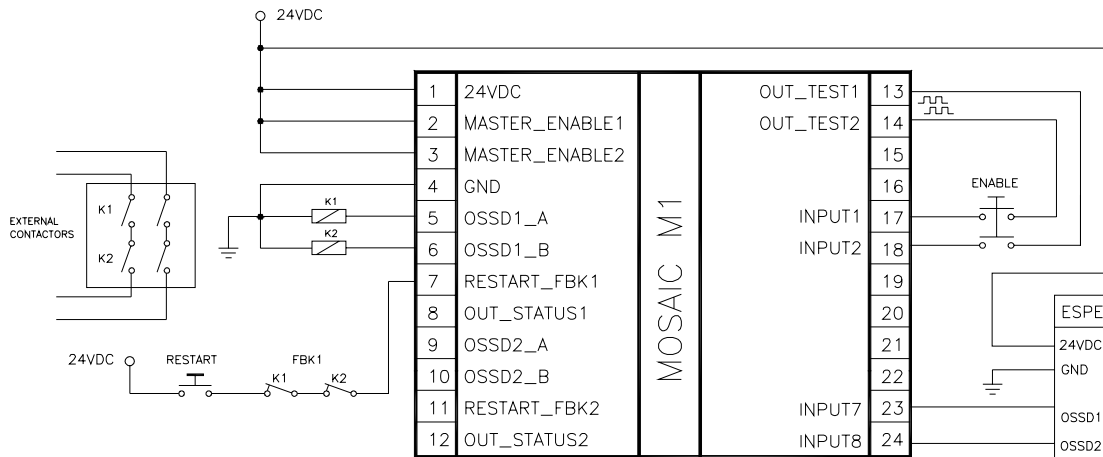

Figure 4

CHECKLIST AFTER INSTALLATION

The MOSAIC system is able to detect the faults that occurs in each own module. Anyway to have the system perfect operation perform the following checks at start up and at least every one year:

1. Operate a complete system TEST (see "TESTING the system")
2. Verify that all the cables are correctly inserted and the terminal blocks well screwed.
3. Verify that all the leds (indicators) light on correctly.
4. Verify the positioning of all the sensors connected to MOSAIC.
5. Verify the correct fixing of MOSAIC to the Omega rail.
6. Verify that all the external indicators (lamps) work properly.

➔ After installation, maintenance and after any eventual configuration change perform a System TEST as described in the paragraph "TESTING the system" at page 52.

OPERATING DIAGRAM

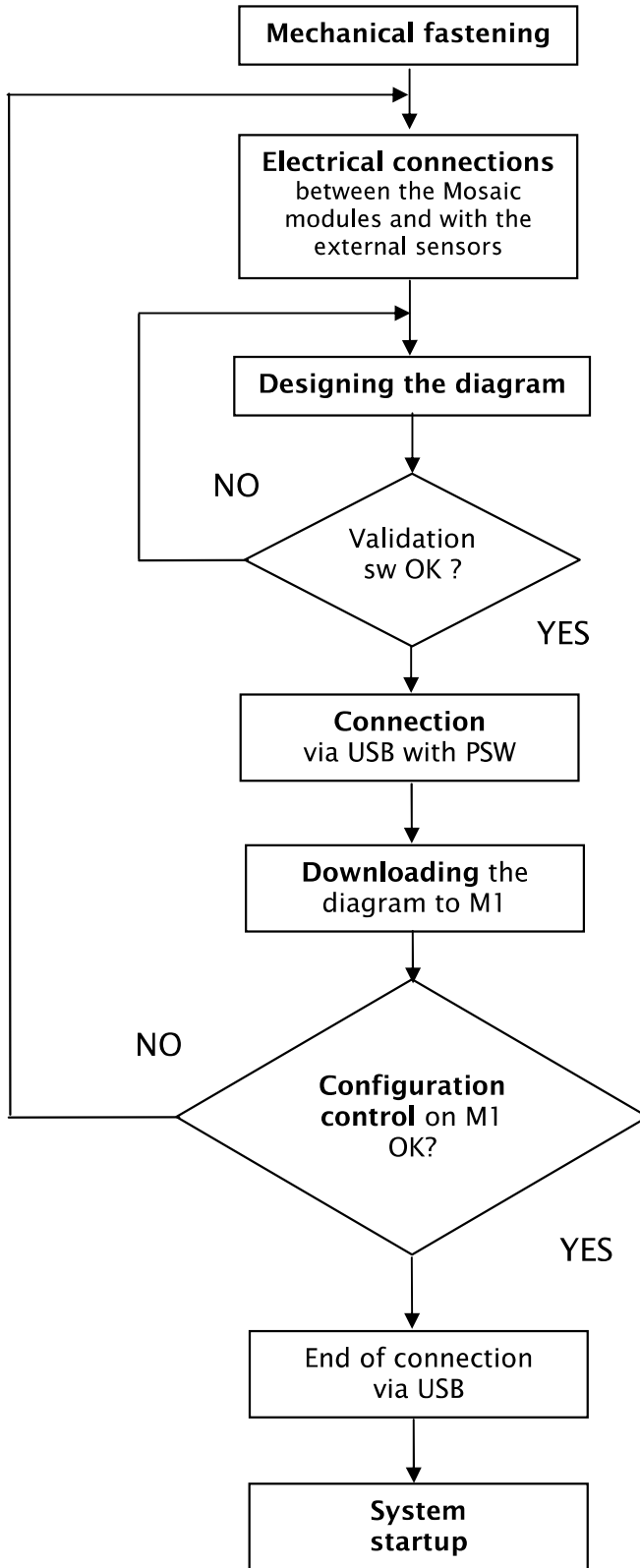

SIGNALS

INPUTS

MASTER ENABLE

The MOSAIC M1 master has two inputs: MASTER_ENABLE1 and MASTER_ENABLE2.

➔ These signals must both be permanently set to logic level 1 (24VDC) for the MOSAIC to operate. If the user needs to disable the MOSAIC simply lower these inputs to logic level 0 (0VDC).

NODE SEL

The NODE_SEL0 and NODE_SEL1 inputs (on the SLAVE units) are used to attribute a physical address to the slave units with the connections shown in Table 9:



	NODE_SEL1	NODE_SEL0
SLAVE 0	0 (or not connected)	0 (or not connected)
SLAVE 1	0 (or not connected)	24VDC
SLAVE 2	24VDC	0 (or not connected)
SLAVE 3	24VDC	24VDC

Table 9

➔ It is not allowed to use the same physical address on two units of the same type.

RESTART_FBK

The RESTART_FBK signal input allows the MOSAIC to verify an EDM (External Device Monitoring) feedback signal (series of contacts) from the external contactors, and to monitor Manual/Automatic operation (See the list of possible connections in Table 10).

-  If the application requires it, the response time of the external contactors must be verified by an additional device.
-  The RESTART command must be installed outside the danger area in a position where the danger area and the entire work area concerned are clearly visible.
-  It must not be possible to reach the control from inside the danger area.



MODE OF OPERATION	EDM	RESTART_FBK	
AUTOMATIC	With K1_K2 control	24V 	
	Without K1_K2 control	24V 	
MANUAL	With K1_K2 control	24V 	
	Without K1_K2 control	24V 	

Table 10

OUTPUTS

OUT STATUS

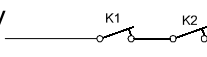
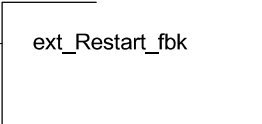
The OUT STATUS signal is a programmable digital output that can indicate the status of:

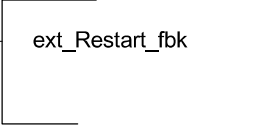
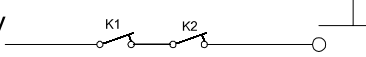
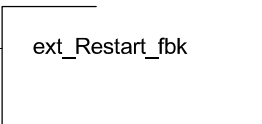
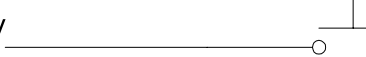
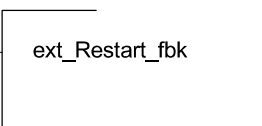
- An input.
- An output.
- A node of the logic diagram designed using the MSD.

OUT TEST

The OUT TEST signals must be used to monitor the presence of short-circuits or overloads on the inputs (Figure 5).

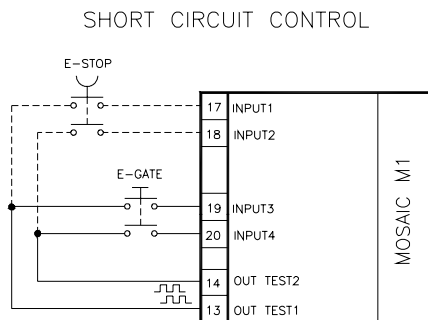

➔ The maximum number of controllable inputs for each output OUT TEST is:

- 2 INPUT (parallel connection) (M1, MI802)
- 4 INPUT (parallel connection) (MI16)

Figure 5

OSSD (M1, MI802)

The OSSD (*static semiconductor safety outputs*) are short circuit protected, cross circuit monitored and supply:

- In the ON condition: $U_v - 0,75V \div U_v$ (where U_v is $24V \pm 20\%$)
- In the OFF condition: $0V \div 2V$ r.m.s.

The maximum load of 400mA@24V corresponds to a minimum resistive load of 60Ω.

The maximum capacitive load is 0.82μF. The maximum inductive load is 30mH.

OSSD (MO2, MO4)

The OSSD (*static semiconductor safety outputs*) are short circuit protected, cross circuit monitored and supply:

- In the ON condition: $U_v - 0,75V \div U_v$ (where U_v is $24V \pm 20\%$)
- In the OFF condition: $0V \div 2V$ r.m.s.

The maximum load of 400mA@24V corresponds to a minimum resistive load of 60Ω.

The maximum capacitive load is 0.82μF. The maximum inductive load is 30mH.

➔ It is not allowed the connection of external devices to the outputs, except as expected in the configuration performed with the MSD software.

Each OSSD output can be configured as shown in Table 11:

Automatic	The output is activated according to le configurations set by the MSD SW only if the corresponding RESTART_FBK input is conected to 24VDC.
Manual	The output is activated according to le configurations set by the MSD SW only if corresponding RESTART_FBK input FOLLOWS A LOGIC TRANSITION OF 0-->1.
Monitored	The output is activated according to le configurations set by the MSD SW only if the corresponding RESTART_FBK input FOLLOWS A LOGIC TRANSITION OF 0-->1-->0.

Table 11

SAFETY RELAYS (MR2, MR4)

Characteristics of the output circuit.

The MR2/MR4 units use guided contact safety relays, each of which provides **two N.O. contacts and one N.C contact in addition to the N.C. feedback contact.** The MR2 unit uses two safety relays and the MR4 uses four.

Excitation voltage	17...31 VDC
Minimum switchable voltage	10 VDC
Minimum switchable current	20 mA
Maximum switchable voltage (DC)	250VDC
Maximum switchable voltage (AC)	400VAC
Maximum switchable current	6A
Response time	12ms
Mechanical life of contacts	> 20 x 10⁶

Table 12

- ➔ To guarantee correct isolation and avoid the risk of premature ageing of or damage to the relays, each output line must be protected using a delay 3.5A fuse and the load characteristics must be consistent with those specified in Table 12.
- ➔ See the "MR2 - MR4" section (for further details on these relays).

MR2/MR4 internal contacts diagram

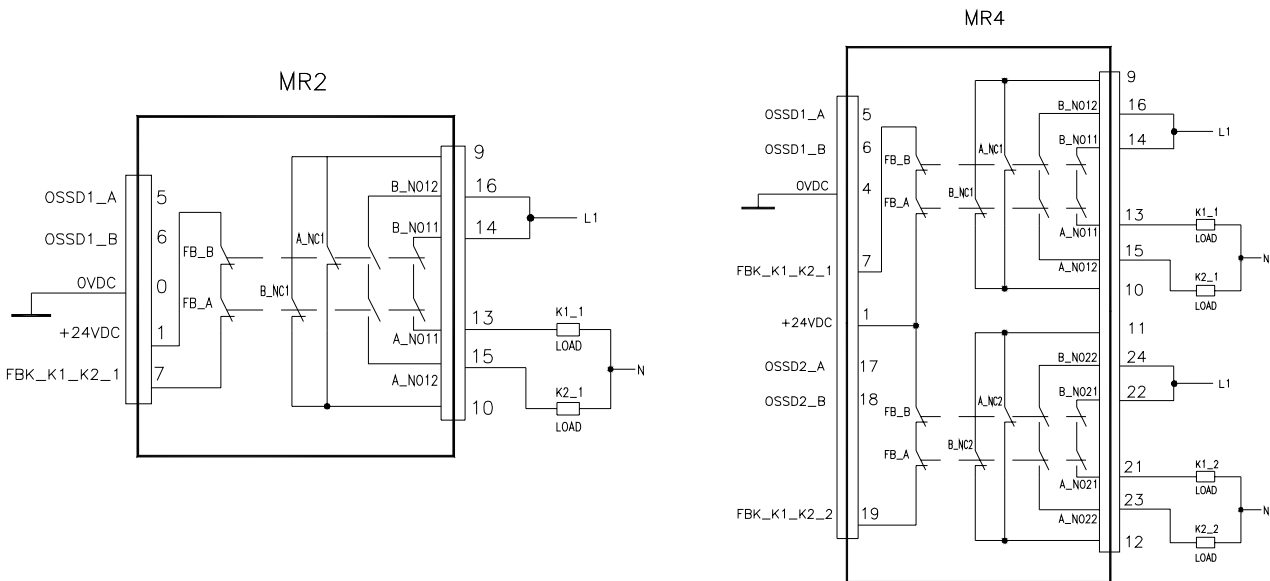

Figure 6

Example of MR2 module connection with static OSSD outputs of a module M1²

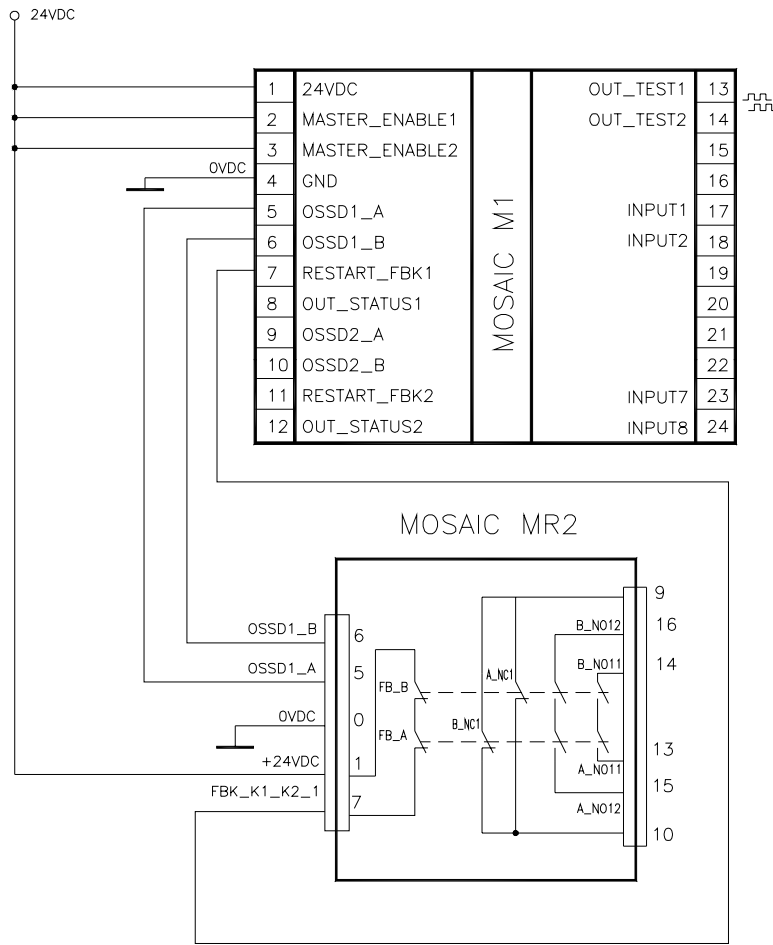

Figure 7

Switching operation timing diagram.

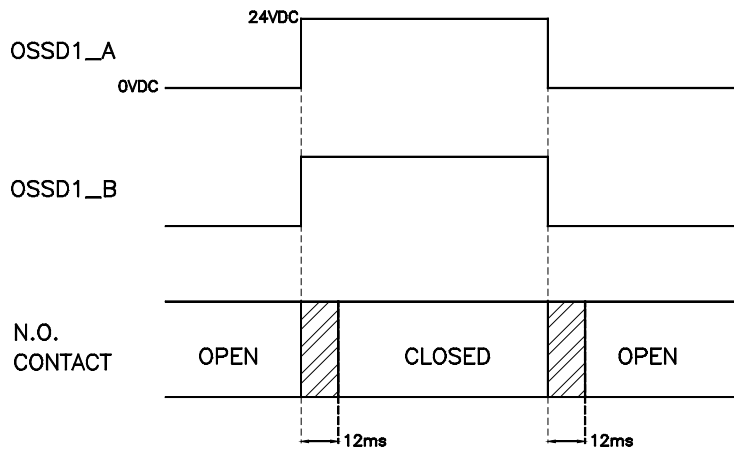

Figure 8

² If a relay module is connected, the response time of the OSSD linked, must be increased of 12ms.

TECHNICAL FEATURES

GENERAL SYSTEM CHARACTERISTICS

Safety level parameters

Parameter	Value	Standard
PFH _d	10 ⁻⁸ ÷ 10 ⁻⁷	IEC 61508:1998
SIL	3	
SILCL	3	IEC 62061:2005
Type	4	EN 61496-1
PL	e	ISO 13849-1:2006 IEC 62061:2005
DC _{avg}	High	
MTTFd (years)	30 ÷ 100	
Category	4	
Device lifetime	20 years	

General data

Max number of inputs	72		
Max number of outputs	8		
Max number of slave units (excluding MR2-MR4)	7		
Max number of slave units of the same type (excluding MR2-MR4)	4		
Rated voltage	24VDC ± 20%		
Digital INPUTS	PNP active high (EN 61131-2)		
OSSD (M1, M1802, MO2, MO4)	PNP active high - 400mA@24VDC max		
Digital OUTPUTS	PNP active high - 100mA@24VDC max		
Response time	Master	10 ms	+ T _{Input_filter}
	M1 + 1 Slave	19.5 ms	+ T _{Input_filter}
	M1 + 2 Slaves	22 ms	+ T _{Input_filter}
	M1 + 3 Slaves	24 ms	+ T _{Input_filter}
	M1 + 4 Slaves	26 ms	+ T _{Input_filter}
	M1 + 5 Slaves	28 ms	+ T _{Input_filter}
	M1 + 6 Slaves	30.5 ms	+ T _{Input_filter}
	M1 + 7 Slaves	32.5 ms	+ T _{Input_filter}
M1> module connection	ReeR proprietary 5-pole bus (MSC)		
Connection cable cross-section	0.5 ÷ 2.5 mm ²		
Max length of connections	100m		
Operating temperature	-10 ÷ 55°C		
Storage temperature	-20 ÷ 70°C		
Relative humidity	10% ÷ 95%		

➔ T_{Input_filter} = max filtering time from among those set on project inputs (see "INPUTS" section).

Enclosure

Description	Electronic housing max 24 pole, with locking latch mounting
Enclosure material	Polyamide
Enclosure protection class	IP 20
Terminal blocks protection class	IP 2X
Fastening	Quick coupling to rail according to EN 60715
Dimensions (h x l x d)	108 x 22.5 x 114.5

M1 module

Rated voltage	24VDC \pm 20%
Dissipated power	3W max
Unit enable (No./description)	2 / PNP active high "type B" according to EN 61131-2
Digital INPUTS (No./description)	8 / PNP active high according to EN 61131-2
INPUT FBK/RESTART (No./description)	2 / EDM control / possible Automatic or Manual operation with RESTART button
Test OUTPUT (No./description)	4 / to check for short-circuits - overloads
Digital OUTPUTS (No./description)	2 / programmable - PNP active high
OSSD (No./description)	2 pairs / solid state safety outputs PNP active high 400mA@24VDC max
SLOT for MCM card	Available
Connection to PC	USB 2.0 (Hi Speed) - Max cable length: 3m
Connection to slave units	via MSC 5-way ReeR proprietary bus

M1802 module

Rated voltage	24VDC \pm 20%
Dissipated power	3W max
Digital INPUTS (No./description)	8 / PNP active high according to EN 61131-2
Test OUTPUT (No./description)	8 / to check for short-circuits - overloads
Digital OUTPUTS (No./description)	2 / programmable - PNP active high
OSSD (No./description)	2 pairs / solid state safety outputs: PNP active high - 400mA@24VDC max
Connection to M1	via MSC 5-way ReeR proprietary bus

MI8 - MI16 modules

Model	MI8	MI16
Rated voltage	24VDC \pm 20%	
Dissipated power	3W max	
Digital INPUTS (No./description)	8	16
	PNP active high according to EN 61131-2	
Test OUTPUT (No./description)	4 / to check for short-circuits - overloads	
Connection to M1	via MSC 5-way ReeR proprietary bus	

MO2 - MO4 modules

Model	MO2	MO4
Rated voltage	24VDC \pm 20%	
Dissipated power	3W max	
Digital OUTPUTS (No./description)	2	4
	programmable - PNP active high	
OSSD (No./description)	2	4
	Solid state safety outputs: PNP active high 400mA@24VDC max	
Connection to M1	via MSC 5-way ReeR proprietary bus	

MR2 - MR4 modules

Model	MR2	MR4
Rated voltage	24VDC \pm 20%	
Dissipated power	3W max	
Switching voltage	240 VAC	
Switching current	6A max	
N.O. contacts	2 N.A. + 1 N.C.	4 N.A. + 2 N.C.
FEEDBACK contacts	1	2
Response time	12ms	
Mechanical life of contacts	$> 20 \times 10^6$	
B10d	AC15 230V	I = 3A: 300.000 I = 1A: 750.000
	DC13 24V	I \leq 2A: 10.000.000
Connection to output module	Via front-panel terminal strip (no connection via MSC bus)	

MECHANICAL DIMENSIONS

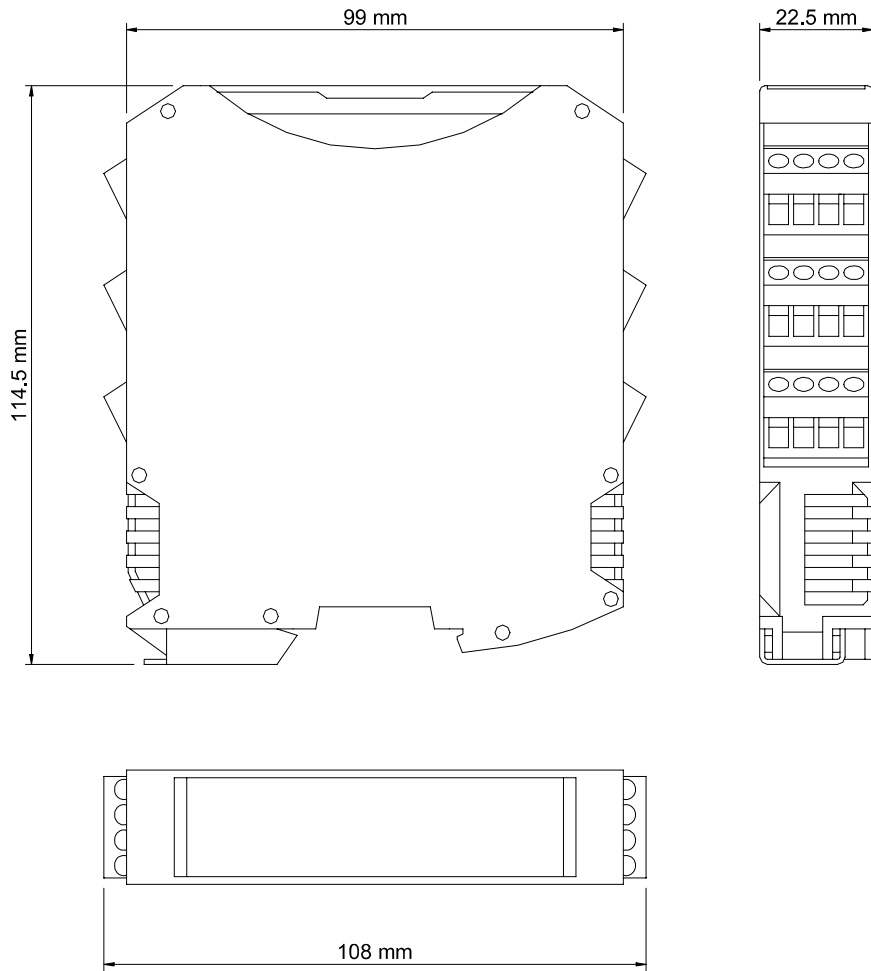

Figure 9

SIGNALS

Master M1 (Figure 10)

MEANING	LED									
	RUN GREEN	IN FAIL RED	EXT FAIL RED	COM ORANGE	ENA BLUE	INI ÷8 YELLOW	OSDD1/2 RED/GREEN	CLEAR1/2 YELLOW	STATUS1/2 YELLOW	
Power on - initial TEST	ON	ON	ON	ON	ON	ON	Red	ON		ON
MCM recognised	OFF	OFF	OFF	ON (max 1s)	ON (max 1s)	OFF	Red	OFF		OFF
Loading diagram from MCM card	OFF	OFF	OFF	5 flashes	5 flashes	OFF	Red	OFF		OFF
MSD requesting connection: internal configuration not present	OFF	OFF	OFF	Flashes slowly	OFF	OFF	Red	OFF		OFF
MSD requesting connection: (slave modules not present or not correct node number)	OFF	OFF	OFF	Flashes quickly	OFF	OFF	Red	OFF		OFF
MSD connected M1 stopped	OFF	OFF	OFF	ON	OFF	OFF	Red	OFF		OFF

Table 13 - Opening Screen

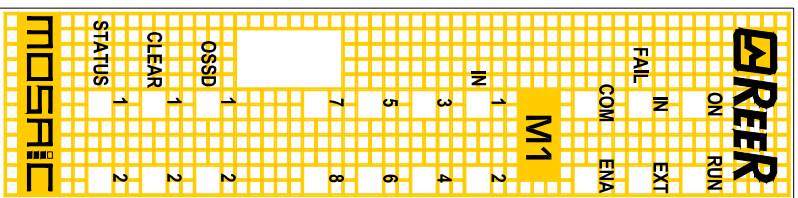

Figure 10 - M1

MEANING	LED									
	RUN GREEN	IN FAIL RED	EXT FAIL RED	COM ORANGE	ENA BLUE	INI ÷8 YELLOW	OSDD1/2 RED/GREEN	CLEAR1/2 YELLOW	STATUS1/2 YELLOW	
NORMAL OPERATION	ON	OFF	OFF op. OK	ON = M1 connected to PC OFF=otherwise	ON MASTER_ENABLE1 and MASTER_ENABLE2 active OFF otherwise	INPUT condition	RED with output OFF GREEN with output ON	ON waiting for RESTART Flashing NO feedback		OUTPUT condition
EXTERNAL FAULT DETECTED	ON	OFF	ON incorrect external connection detected	ON = M1 connected to PC OFF=otherwise	only the number of the INPUT with the incorrect connection flashes					

Table 14 - Dynamic Screen

M1802 (Figure 11)

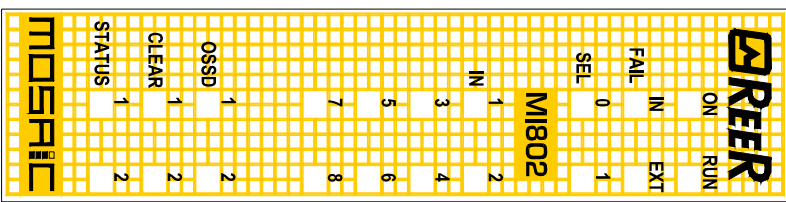

Figure 11 - M1802

MEANING	LED							
	RUN GREEN	IN FAIL RED	EXT FAIL RED	SEL ORANGE	IN1 ÷ 8 YELLOW	OSSD1 / 2 RED/GREEN	CLEAR1 / 2 YELLOW	STATUS1 / 2 YELLOW
Power on - initial TEST	ON	ON	ON	ON	ON	Red	ON	ON

Table 15 - Opening Screen

MEANING	LED							
	RUN GREEN	IN FAIL RED	EXT FAIL RED	IN1 ÷ 8 YELLOW	SEL ORANGE	OSSD1 / 2 RED/GREEN	CLEAR1 / 2 YELLOW	STATUS1 / 2 YELLOW
NORMAL OPERATION	OFF if the unit is waiting for the first communication from the MASTER	OFF	OFF	INPUT condition	Shows the NODE_SEL0/1 signal table	RED with output with output OFF	ON waiting for RESTART	OUTPUT condition
			ON if INPUT or OUTPUT requested by the configuration	ON incorrect external connection detected		only the number of the INPUT with the incorrect connection flashes	GREEN with output ON	Flashes NO feedback

Table 16 - Dynamic Screen

MI8 (Figure 12)

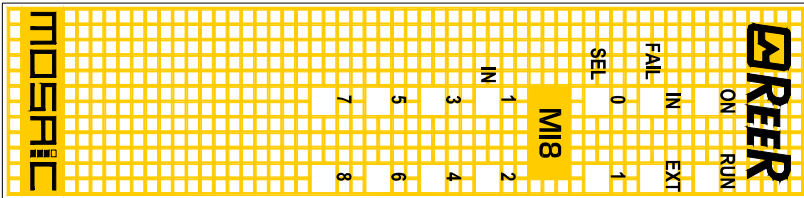

Figure 12 - MI8

MEANING	LED					
	RUN GREEN	IN FAIL RED	EXT FAIL RED	SEL ORANGE	IN1 ÷8 YELLOW	IN1 ÷8 YELLOW
Power on - initial TEST	ON	ON	ON	ON	ON	ON

Table 17 - Opening Screen

MEANING	LED					
	RUN GREEN	IN FAIL RED	EXT FAIL RED	SEL ORANGE	IN1 ÷8 YELLOW	IN1 ÷8 YELLOW
NORMAL OPERATION	OFF if the unit is waiting for the first communication from the MASTER FLASHES if no INPUT or OUTPUT requested by the configuration ON if INPUT or OUTPUT requested by the configuration	OFF	OFF	ON incorrect external connection detected	Shows the NODE_SEL0/1 signal table	INPUT condition
			ON	only the number of the INPUT with the incorrect connection flashes		

Table 18 - Dynamic Screen

MI16 (Figure 13)

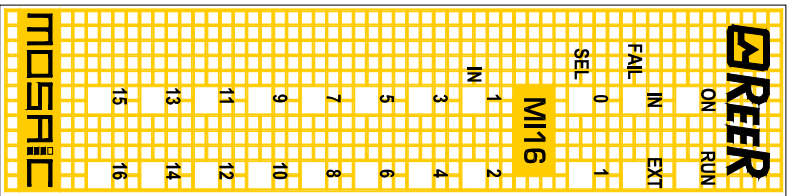

Figure 13 - MI16

MEANING	RUN		IN FAIL		EXT FAIL		SEL		IN1 ÷ 16	
	GREEN	ON	RED	ON	RED	ON	ORANGE	ON	YELLOW	ON
Power on - Initial TEST										

Table 19 - Opening Screen

MEANING	RUN GREEN	IN FAIL RED	LED		SEL ORANGE	IN1 ÷ 16 YELLOW
			EXT FAIL RED	Shows the NODE_SELO/1 signal table		
NORMAL OPERATION	OFF if the unit is waiting for the first communication from the MASTER FLASHES if no INPUT or OUTPUT requested by the configuration ON if INPUT or OUTPUT requested by the configuration	OFF	OFF	INCORRECT EXTERNAL CONNECTION DETECTED	INPUT condition	only the number of the INPUT with the incorrect connection Flashes
			ON			

Table 20 - Dynamic Screen

MO2 (Figure 14)

MEANING	LED						
	RUN GREEN	IN FAIL RED	EXT FAIL RED	SEL ORANGE	OSDD1/2 RED/GREEN	CLEAR1/2 YELLOW	STATUS1/2 YELLOW
Power on - initial TEST	ON	ON	ON	ON	Red	ON	ON

Table 21 - Opening screen

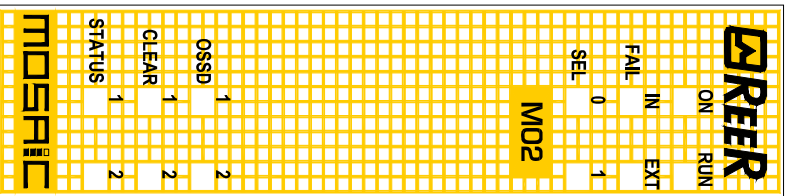

Figure 14 - MO2

MEANING	LED						
	RUN GREEN	IN FAIL RED	EXT FAIL RED	SEL ORANGE	OSDD1/2 RED/GREEN	CLEAR1/2 YELLOW	STATUS1/2 YELLOW
NORMAL OPERATION	OFF if the unit is waiting for the first communication from the MASTER FLASHES if no INPUT or OUTPUT requested by the configuration ON if INPUT or OUTPUT requested by the configuration	OFF op. OK	OFF op. OK	Shows the NODE_SELO/1 signal table	RED with output OFF	ON waiting for RESTART	OUTPUT condition
					GREEN with output ON	Flashes NO feedback	

Table 22 - Dynamic screen

MO4 (Figure 15)

MEANING	LED						
	RUN GREEN	IN FAIL RED	EXT FAIL RED	SEL ORANGE	OSDD1/4 RED/GREEN	CLEAR1/4 YELLOW	STATUS1/4 YELLOW
Power on - initial TEST	ON	ON	ON	ON	Red	ON	ON

Table 23 - Opening screen

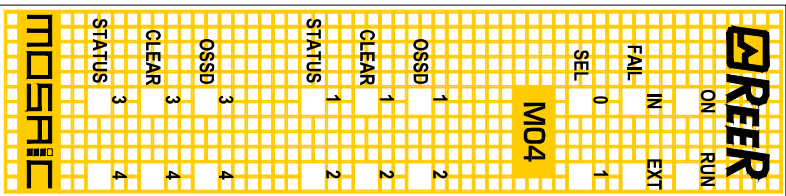

Figure 15 - MO4

MEANING	LED						
	RUN GREEN	IN FAIL RED	EXT FAIL RED	SEL ORANGE	OSDD1/4 RED/GREEN	CLEAR1/4 YELLOW	STATUS1/4 YELLOW
NORMAL OPERATION	OFF if the unit is waiting for the first communication from the MASTER FLASHES if no INPUT or OUTPUT requested by the configuration ON if INPUT or OUTPUT requested by the configuration	OFF op. OK	OFF op. OK	Shows the NODE_SELO/1 signal table	RED with output OFF GREEN with output ON	ON waiting for RESTART Flashes NO feedback	OUTPUT condition

Table 24 - Dynamic screen

MR2 (Figure 16) / MR4 (Figure 17)

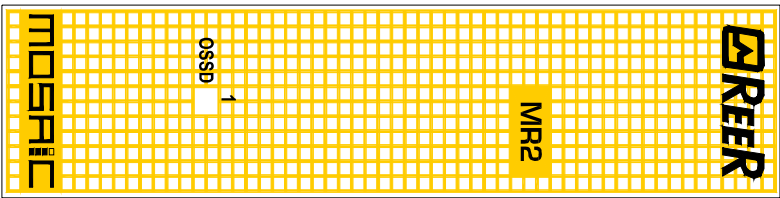

Figure 16 - MR2

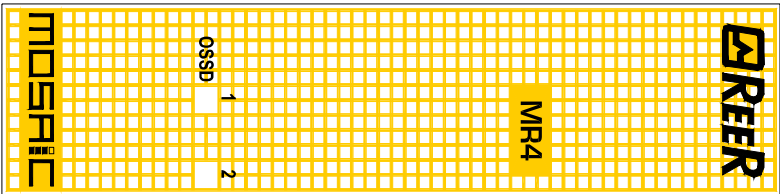

Figure 17 - MR4

MEANING	LED
	OSSD1 GREEN
NORMAL OPERATION	ON with output activated

Table 25 - MR2 - Dynamic screen

MEANING	LED	
	OSSD1 GREEN	OSSD2 GREEN
NORMAL OPERATION	ON with output activated	

Table 26 - MR4 - Dynamic screen

TROUBLESHOOTING

Master M1 (Figure 18)

MEANING	LED								REMEDY	
	RUN GREEN	IN FAIL RED	EXT FAIL RED	COM ORANGE	INI ÷8 YELLOW	ENA BLUE	OSSD1/2 RED/GREEN	CLEAR1/2 YELLOW		STATUS1/2 YELLOW
Internal fault	OFF	2 or 3 flashes	OFF	OFF	OFF	OFF	Red	OFF	OFF	Return the unit to Reer to be repaired
Configuration error	OFF	5 flashes	OFF	OFF	5 flashes	OFF	5 flashes	5 flashes	5 flashes	<ul style="list-style-type: none"> Upload the project to the MOSAIC again. If the problem persists return the M1 to Reer to be repaired
OSSD output error	OFF	4 flashes	OFF	OFF	OFF	OFF	4 flashes (only the LED corresponding to the output in FAIL mode)	OFF	OFF	<ul style="list-style-type: none"> Check the OSSD1/2 connections If the problem persists return the M1 to Reer to be repaired
Error in communication with slave	OFF	5 flashes	OFF	OFF	OFF	OFF	OFF	OFF	OFF	<ul style="list-style-type: none"> Restart the system. If the problem persists return the M1 to Reer to be repaired
Slave unit error	OFF	ON	OFF	OFF	OFF	OFF	OFF	OFF	OFF	<ul style="list-style-type: none"> Restart the system Check which unit is in FAIL mode
MCM error	OFF	6 flashes	OFF	6 flashes	OFF	OFF	OFF	OFF	OFF	Replace the MCM

Table 27 - Troubleshooting M1

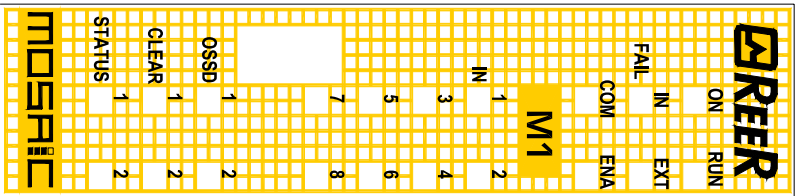
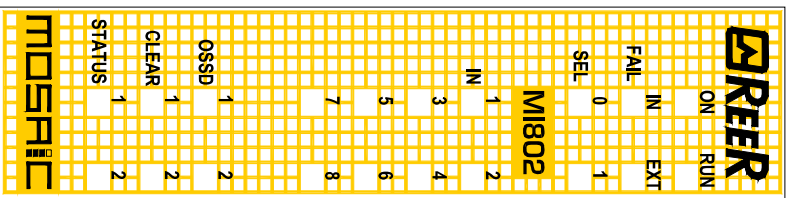

Figure 18 - M1

MI802 (Figure 19)



MEANING	RUN		IN FAIL RED	EXT FAIL RED	SEL ORANGE	LED					REMEDY
	GREEN	OFF				INI ÷8 YELLOW	OSSD1/2 RED/GREEN	CLEAR1/2 YELLOW	STATUS1/2 YELLOW		
Internal fault	OFF	OFF	2 or 3 flashes	OFF		OFF	Red	OFF	OFF	Return the unit to Reer to be repaired	
Compatibility error	OFF	OFF	5 flashes	OFF		5 flashes	5 flashes	5 flashes	5 flashes	<ul style="list-style-type: none"> Firmware version not compatible with M1, return to Reer for FW upgrade. 	
OSSD output error	OFF	OFF	4 flashes	OFF		OFF	4 flashes (only the LED corresponding to the output in FAIL mode)	OFF	OFF	<ul style="list-style-type: none"> Check OSSD1/2 connections If the problem persists, return the MI802 to Reer to be repaired 	
Error in communication with master	OFF	OFF	5 flashes	OFF		Shows the physical address of the unit	OFF	OFF	OFF	<ul style="list-style-type: none"> Restart the system If the problem persists, return the MI802 to Reer to be repaired 	
Error on other slave or M1	OFF	OFF	ON	OFF		OFF	OFF	OFF	OFF	<ul style="list-style-type: none"> Restart the system Check which unit is in FAIL mode 	
Same type of slave with same address detected	OFF	OFF	5 flashes	OFF		OFF	OFF	OFF	OFF	<ul style="list-style-type: none"> Change the unit's address (see NODE SEL) 	

Table 28 - Troubleshooting MI802

Figure 19 - MI802

M18 (Figure 20)

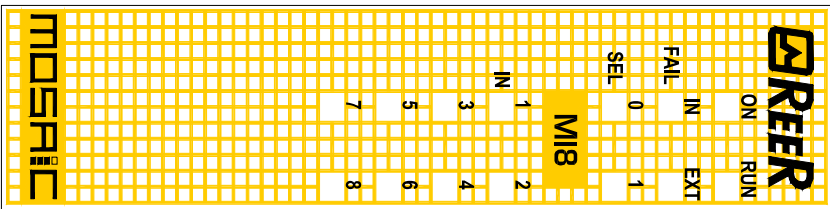

Figure 20 - M18

MEANING	LED								REMEDY
	RUN GREEN	IN FAIL RED	EXT FAIL RED	SEL ORANGE	INI-8 YELLOW	OSSD1/2 RED/GREEN	CLEAR1/2 YELLOW	STATUS1/2 YELLOW	
Internal fault	OFF	2 or 3 flashes	OFF		OFF	Red	OFF	OFF	Return the unit to Reer to be repaired
Compatibility error	OFF	5 flashes	OFF	Shows the physical address of the unit	5 flashes	5 flashes	5 flashes	5 flashes	<ul style="list-style-type: none"> Firmware version not compatible with M1, return to Reer for FW upgrade.
Error in communication with master	OFF	5 flashes	OFF		OFF	OFF	OFF	OFF	<ul style="list-style-type: none"> Restart the system If the problem persists, return the M18 to Reer to be repaired
Error on other slave or M1	OFF	ON	OFF		OFF	OFF	OFF	OFF	<ul style="list-style-type: none"> Restart the system Check which unit is in FAIL mode
Same type of slave with same address detected	OFF	5 flashes	5 flashes		OFF	OFF	OFF	OFF	<ul style="list-style-type: none"> Change the unit's address (see NODE SEL)

Table 29 - Troubleshooting M18

MI16 (Figure 21)

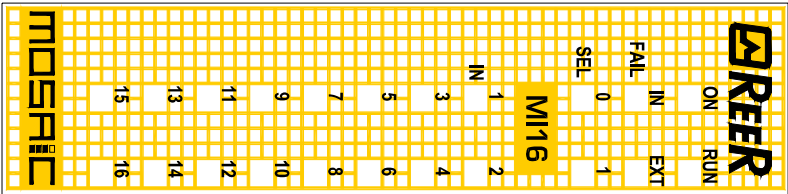

Figure 21 - MI16

MEANING	LED							REMEDY	
	RUN GREEN	IN FAIL RED	EXT FAIL RED	SEL ORANGE	LED IN1÷16 YELLOW	OSSD1/2 RED/GREEN	CLEAR1/2 YELLOW		STATUS1/2 YELLOW
Internal fault	OFF	2 or 3 flashes	OFF		OFF	Red	OFF	OFF	Return the unit to Reer to be repaired
Compatibility error	OFF	5 flashes	OFF		5 flashes	5 flashes	5 flashes	5 flashes	• Firmware version not compatible with M1, return to Reer for FW upgrade.
Error in communication with master	OFF	5 flashes	OFF	Shows the physical address of the unit	OFF	OFF	OFF	OFF	• Restart the system • If the problem persists, return the MI16 to Reer to be repaired
Error on other slave or M1	OFF	ON	OFF		OFF	OFF	OFF	OFF	OFF
Same type of slave with same address detected	OFF	5 flashes	5 flashes		OFF	OFF	OFF	OFF	• Change the unit's address (see NODE SEL)

Table 30 - Troubleshooting MI16

MO2 / MO4 (Figure 22)

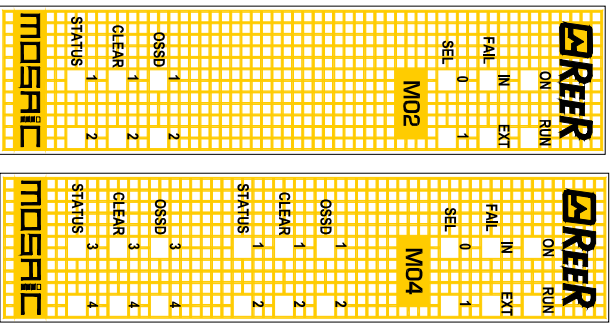

Figure 22 - MO2 / MO4

MEANING	LED				SEL ORANGE	LED			REMEDY
	RUN GREEN	IN FAIL RED	EXT FAIL RED	OSSD1 /4 RED/GREEN		CLEAR1 /2 YELLOW	STATUS1 /2 YELLOW		
Internal fault	OFF	2 or 3 flashes	OFF	Red		OFF	OFF	Return the unit to Reer to be repaired	
Compatibility error	OFF	5 flashes	OFF	5 flashes		5 flashes	5 flashes	<ul style="list-style-type: none"> Firmware version not compatible with M1, return to Reer for FW upgrade. 	
OSSD output error	OFF	4 flashes	OFF	4 flashes (only the LED corresponding to the output in FAIL mode)	Shows the physical address of the unit	OFF	OFF	<ul style="list-style-type: none"> Check OSSD1 /2 connections If the problem persists, return the MO2/4 to Reer to be repaired 	
Error in communication with master	OFF	5 flashes	OFF	OFF		OFF	OFF	<ul style="list-style-type: none"> Restart the system If the problem persists, return the M1802 to Reer to be repaired 	
Error on other slave or M1	OFF	ON	OFF	OFF		OFF	OFF	<ul style="list-style-type: none"> Restart the system Check which unit is in FAIL mode 	
Same type of slave with same address detected	OFF	5 flashes	5 flashes	OFF		OFF	OFF	<ul style="list-style-type: none"> Change the unit's address (see NODE SEL) 	

Table 31 - Troubleshooting MO2/MO4

MOSAIC SAFETY DESIGNER SOFTWARE

The "**MOSAIC SAFETY DESIGNER**" application software can be used to configure a logic diagram of the connections between the MOSAIC (Master + expansions) and the components of the system being developed.

The MOSAIC and its SLAVE units will thus monitor and control the connected safety components.

The MSD uses a versatile graphic interface to establish the connections between the various components, as described below:

Installing the software

PC HARDWARE requirements

- RAM: 256 MB
(adequate to run *Windows XP SP3 + Framework 3.5*)
- Hard disk: \geq 100Mbyte of free space
- USB connector: 1.1 or 2.0
- CD-ROM drive

PC SOFTWARE requirements

- Windows XP with Service Pack 3 installed (or higher OS).

➔ Microsoft Framework 3.5 (or higher) must be installed on the PC

How to install MSD

- Insert the installation CD;
- Wait for the auto-run installer to request the SW setup program;

Alternatively follow the path D:/;

- Double-click on the **SetupMSD.exe** file;

When the installation procedure is complete a window is displayed asking you to close the setup program.

Fundamentals

Once the MSD has been correctly installed it creates an icon on the desktop. To launch the program: double-click on this icon. =>



The opening screen shown below is displayed:

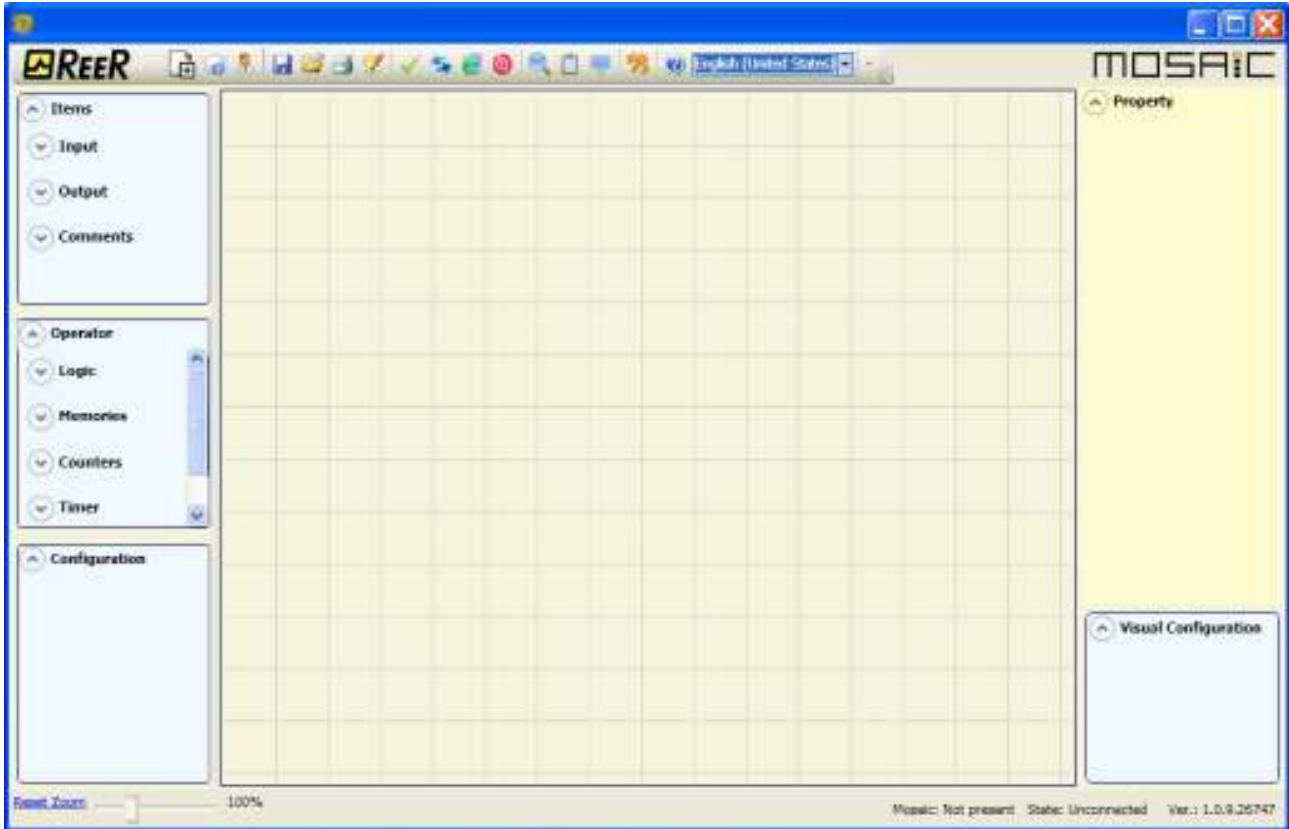

Figure 23

You are now ready to create your project.

Standard tool bar

The standard tool bar is shown in Figure 24. The meanings of the icons are listed below:

















- 1 ->  **CREATE A NEW PROJECT**
- 2 ->  **CHANGE CONFIGURATION** (composition of different modules)
- 3 ->  **CHANGE USER PARAMETERS** (name, company, etc)
- 4 ->  **SAVE THE ACTUAL PROJECT**
- 5 ->  **LOAD AN EXISTING PROJECT**
- 6 ->  **PRINT THE PROJECT SCHEMATIC**
- 7 ->  **PRINT THE PROJECT REPORT**
- 8 ->  **VALIDATE THE PROJECT**
- 9 ->  **CONNECT TO MOSAIC**
- 10 ->  **SEND PROJECT TO MOSAIC**
- 11 ->  **DISCONNECT FROM MOSAIC**
- 12 ->  **MONITOR** (Real time I/O status - **graphic**)
- 13 ->  **MONITOR** (Real time I/O status - **textual**)
- 14 ->  **UPLOAD LOG FILE**
- 15 ->  **UPLOAD SYSTEM CONFIGURATION**
- 16 ->  **CHANGE PASSWORD**
- 17 ->  **ON-LINE HELP**



Figure 24

Create a new project (configure the MOSAIC system)

Select icon CREATE (Figure 24) from the standard tool bar to start a new project. The user authentication window is displayed (Figure 25).

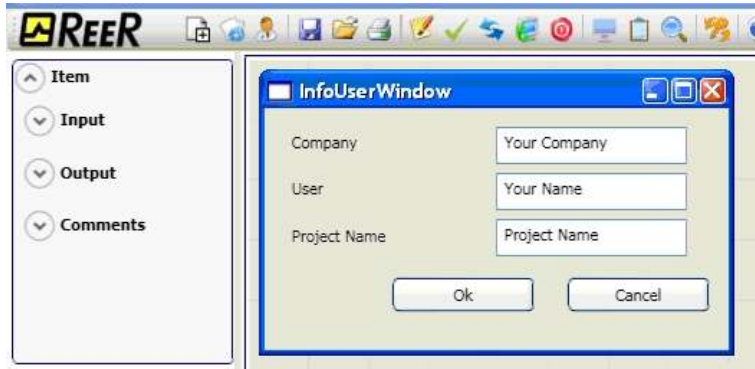

Figure 25

Next the MSD displays a window showing the M1 only. You may add the various units needed to create your system, using the pull-down menus at the top of the screen (select slave) and at the bottom to select the relative node (0÷3).

SELECT SLAVE (to add to your configuration)

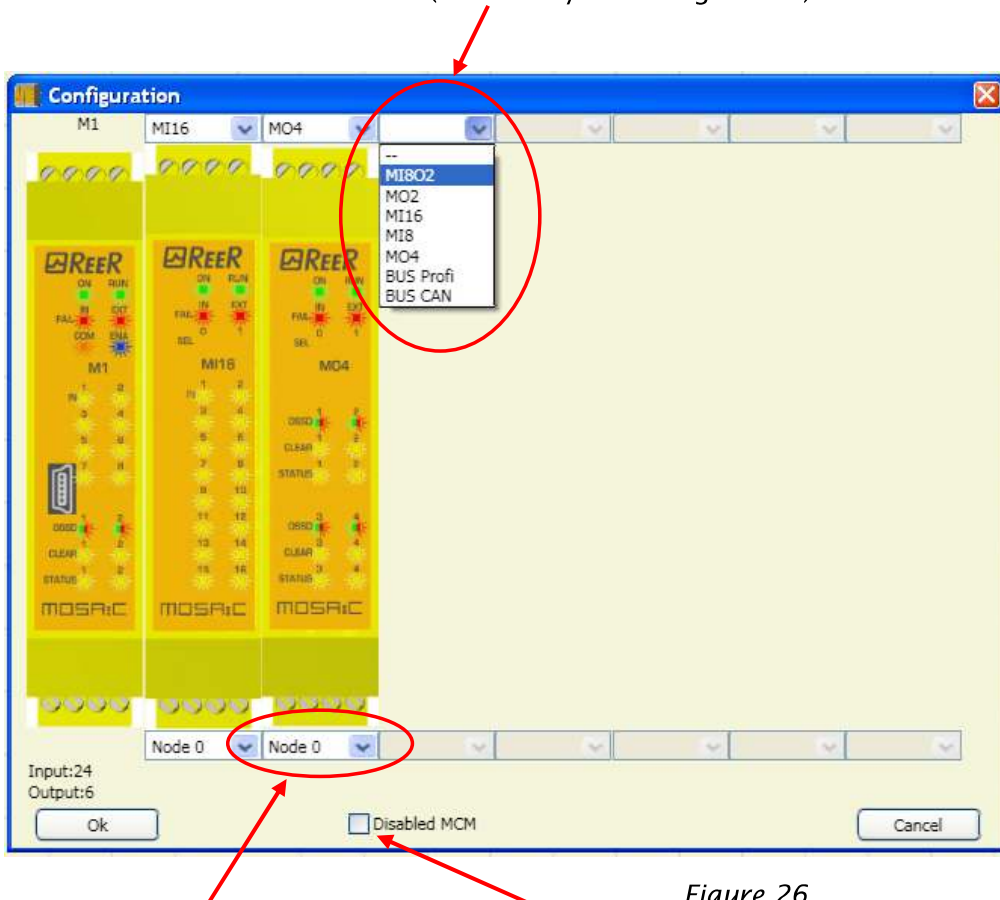

Figure 26

SELECT NODE (from 0 to 3)

Select to disable MCM operations

EDIT CONFIGURATION (composition of the various modules)

The change of the system composition is obtained with the icon .

The configuration window is showed again (Figure 24).

Change user parameters

The change of user parameters is obtained with the icon .

The dialog user identification request appears (Figure 27). To accomplish this operation is not necessary to Log out from Mosaic. Generally it serves when a new user must create a new project (even using a previously created).

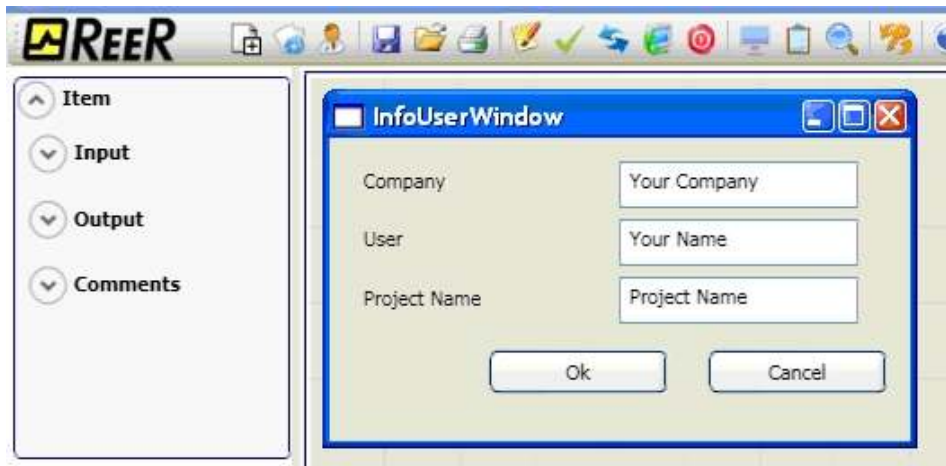

Figure 27

OBJECTS - OPERATOR - CONFIGURATION tool bars

Four large tool windows are displayed to the left and right of the main window (shown in Figure 28):

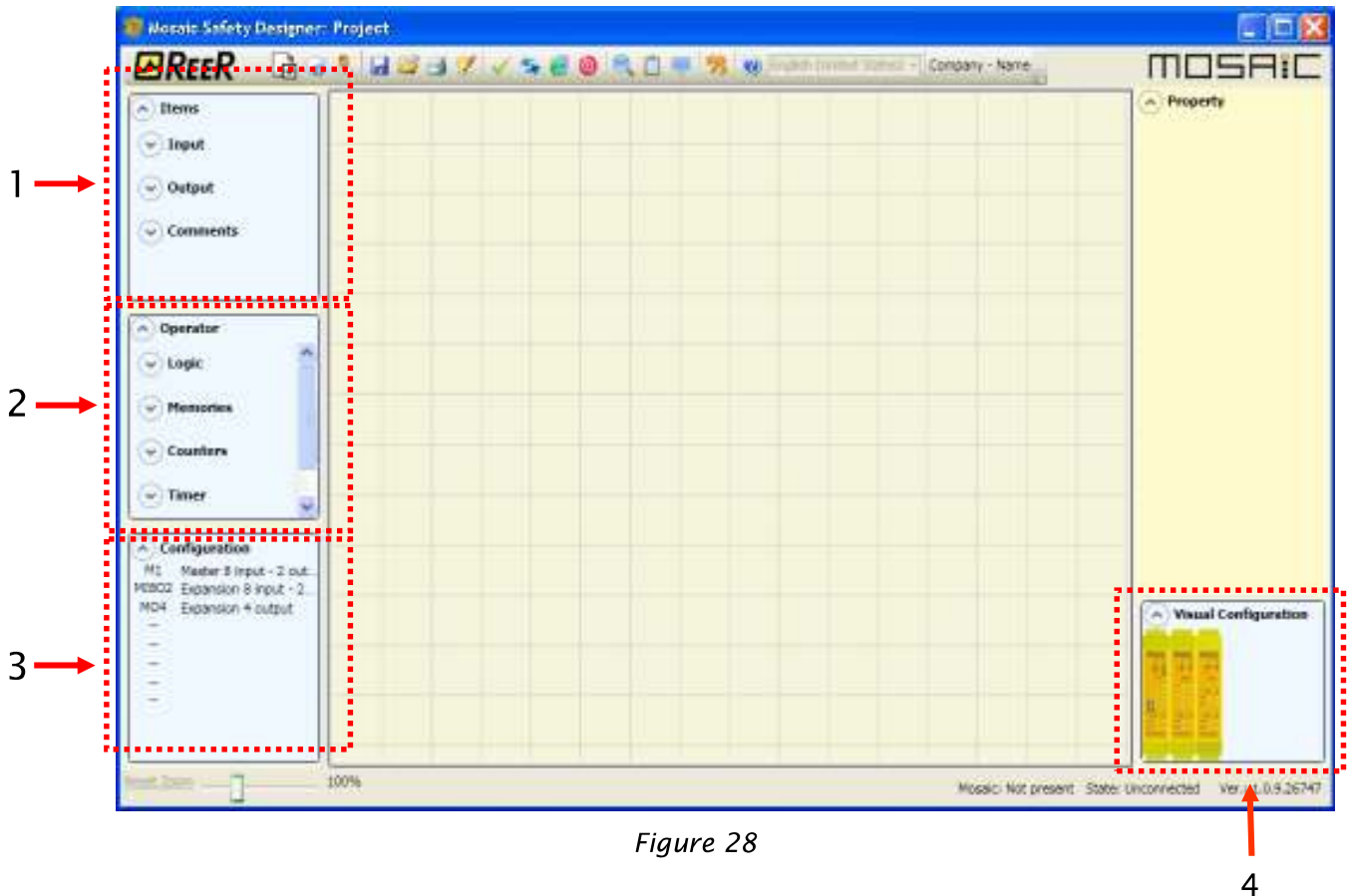

Figure 28

1 > OBJECT TOOL WINDOW

This contains the various function blocks that will make up your project; these blocks are divided into 3 different types:

- physical
- inputs
- outputs
- comments

2 > OPERATOR TOOL WINDOW

This contains the various function blocks for connecting the objects in point 1; these blocks are divided into 5 different types:

- logical
- muting
- memories
- counters
- timers

3 > CONFIGURATION TOOL WINDOW

This contains the description of your project composition.

4 > CONFIGURATION TOOL WINDOW (view)

This contains the graphic representation of your project composition.

Creating the diagram (Figure 16)

Once you have selected your system composition, you are ready to configure the project. The logic diagram is created using a **DRAG&DROP** function:

- Select the objects as required from the windows described previously (each single object is described in detail in the following sections) and drag it into the design area.
- Now when you select the object the **PROPERTIES** window is enabled, where you must fill in the fields as required.
- When you need to set a specific numerical value with a slide (eg filter) use the left and right arrows on your keyboard or click the sides of the slider of the slide.
- Connect the objects by moving the mouse over the required pin and then dragging it onto the pin to be connected.
- If the scheme requires the PAN function (moving working area in the window), select the object to move and use the arrow keys on your keyboard.
- When you need to delete an object or a link, select it and press DEL key on your keyboard.

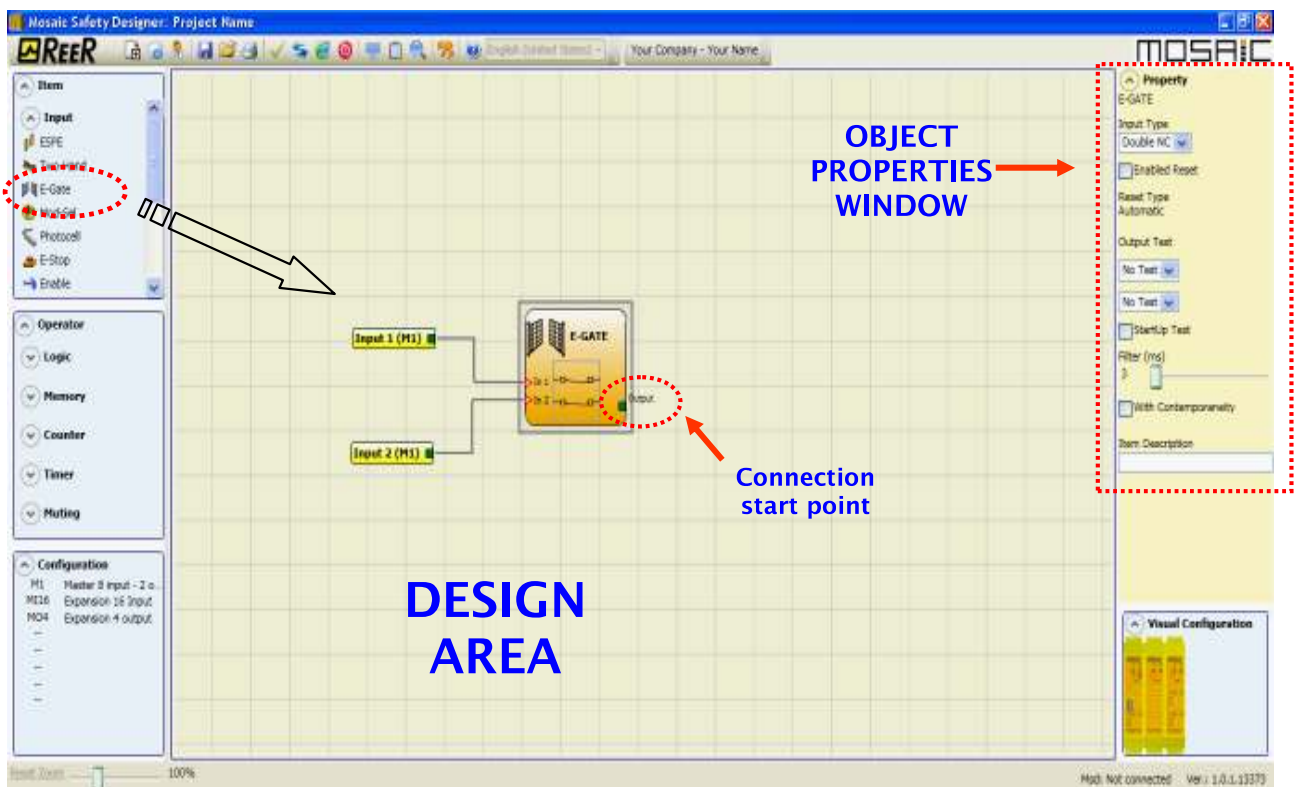

Figure 29

Example of a project

Figure 30 shows an example of a project in which the M1 unit only is connected to two safety blocks (E-GATE and E-STOP).

The M1 inputs (1,2,3) for connecting the contacts of the safety components are shown on the left, in yellow. The MOSAIC outputs (from 1 to 4) are activated according to the conditions defined in E-GATE and E-STOP (see the E-GATE - E-STOP sections).

By clicking on a block to select it, you enable the PROPERTIES WINDOW on the right, which you can use to configure the block activation and test parameters (see the E-GATE - E-STOP sections).

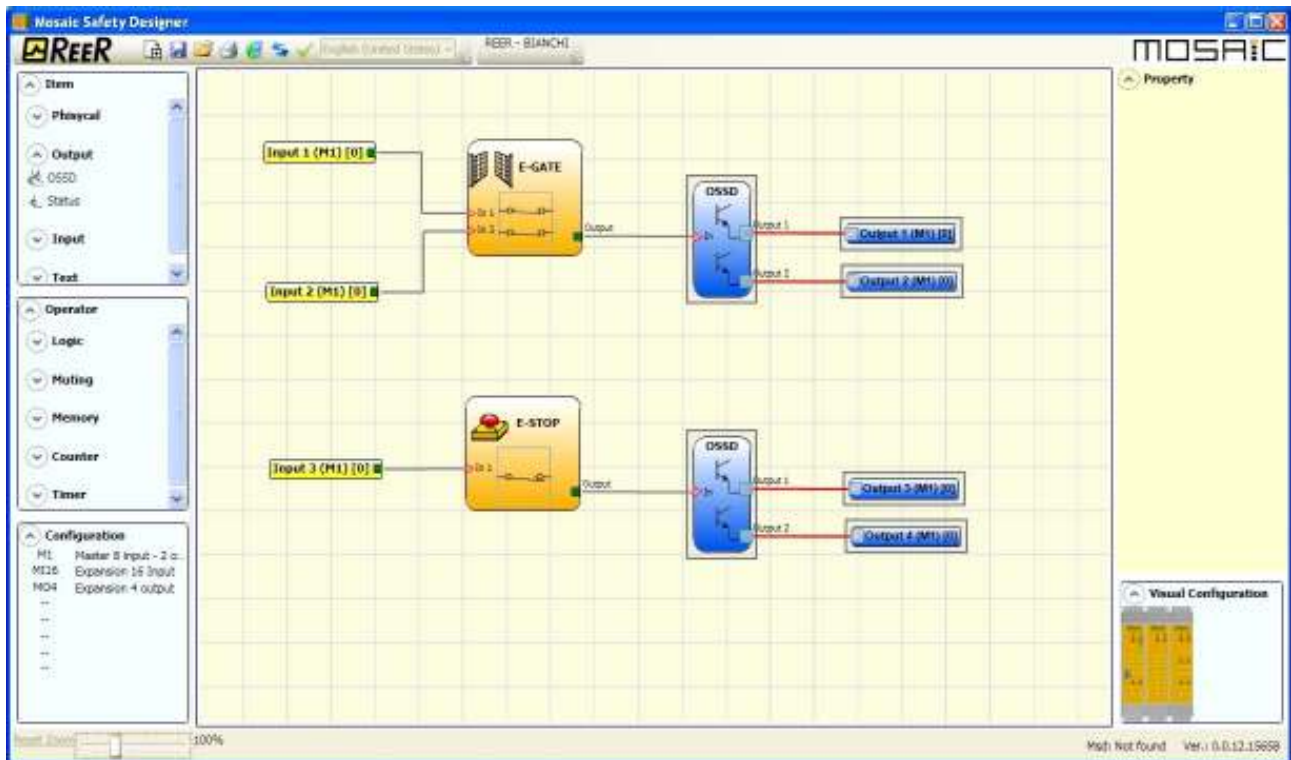

Figure 30

At the end of the project design stage (or at intermediate steps) you can save the current configuration using the icon **SAVE** on the standard tool bar.

Project validation

➔ Now the finished project must be verified. Execute the VALIDATE command (Icon on the standard toolbar).

If the validation is successful, a sequential number is assigned to the input and output of the project. Then, this number is also listed in the REPORT and in the MONITOR of MSD.

Only if the validation is successful we will proceed to send the configuration.

Project report

Print of the System composition with properties of each block. (Icon on the standard toolbar).

Connect to Mosaic



After connecting M1 to the PC via CSU cable (USB) use the icon  for the connection. A window appears to request the password. Enter the password (see "Password protection").



Figure 31

Sending the configuration to the MOSAIC

To send the saved configuration from a PC to M1 use the icon  on the standard toolbar and wait the execution. M1 will save the project in its internal memory and (if present) in MCM memory. (Password Required: level 2).

➔ This function is possible only after the project validation.

Configuration LOG

- ➔ Within the configuration file (project), are included the **creation date** and **CRC (4-digit hexadecimal identification)** of a project that are stored in M1.
- ➔ This logbook can record up to 5 consecutive events, after which these are overwritten, starting from the least recent event.

The log file can be visualized using the icon  in the standard tool bar. (Password Required: level 1).

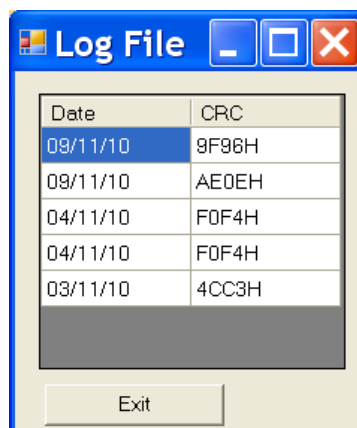

Figure 32

Upload system configuration

The check of the actual composition of the MOSAIC system is obtained using the icon

. (Password Required: level 1). A pop-up window will appear with:

- Connected modules;
- Firmware version of each module;
- Node number (physical address) of each module.



Figura 33

Disconnecting System

To disconnect the PC from M1 use the icon ; when the system is disconnected it is resetted and it starts with the sent project.

➔ If the system is not composed of all modules provided by the configuration, after the disconnection, M1 indicates the incongruity and does not starts. (See SIGNALS).

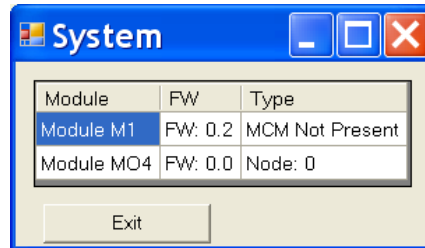
MONITOR (I/O status in real time - textual)

To activate the monitor use the icon . (Password Required: level 1). A pop-up window will appear (**in real time**) with:

- Status of the inputs (when the object has two or more input connections to Mosaic, the MONITOR will show as active only the first), see the example in figure;
- Inputs Diagnostics;
- OSSD State;
- OSSD Diagnostics;
- Status of digital outputs;
- OUT TEST diagnostics.



Figure 34 - textual monitor

MONITOR (I/O status in real time - textual - graphic)

To activate/deactivate the monitor use the icon . (Password Required: level 1).
The color of links (Figure 33) allows you to view the diagnostics (**in real time**) with:

RED = OFF

GREEN = ON

DASHED ORANGE = Connection Error

DASHED RED = Pending enable (for example RESTART)

Placing the mouse pointer over the link, you can display the diagnostics.

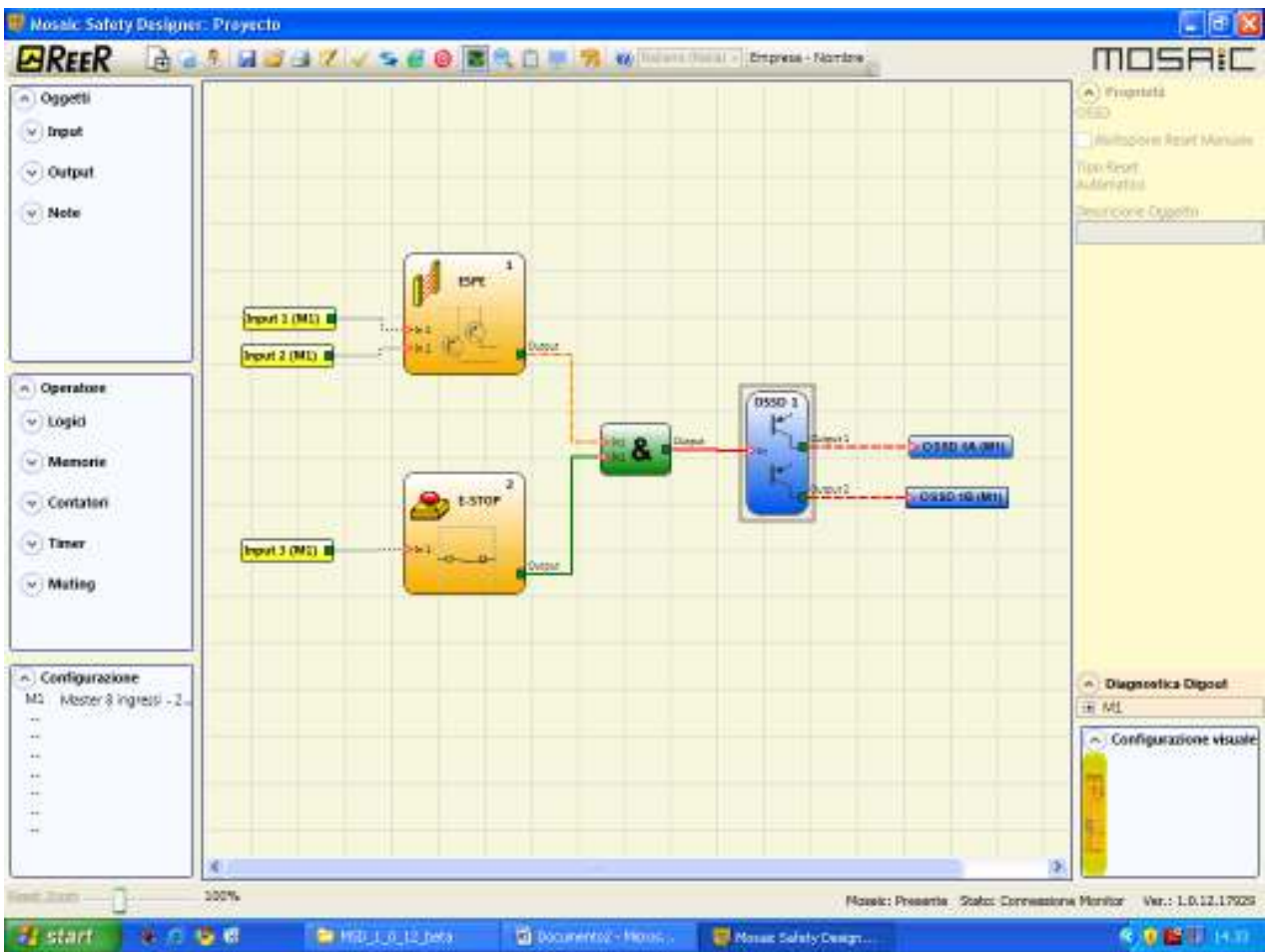

Figure 35 - graphic monitor

Password protection

The MSD requests a password in order to upload and save the project.

Level 1 password

All operators using the M1 system must have a Level 1 PASSWORD.

This Password allows only to view the LOG file, composition of the system and MONITOR in real time.

The first time the system is initialised the operator must use the password "" (ENTER key).

Designers who know the level 2 password can enter a new level 1 password (alphanumerical, max 8 characters).

➔ Operators who know this password **are not enabled** to upload, modify or save the project.

Level 2 password

Designers authorised to work on the creation of the project must know a Level 2 PASSWORD. The first time the system is initialised the operator must use the password "SAFEPASS" (all capital letters).

Designers who know the level 2 password can enter a new level 2 password (alphanumerical, max 8 characters).

- ➔ This password **enables** the project to be uploaded, modified and saved. In other words, it allows total control of the PC => MOSAIC system.
- ➔ When a new project is UPLOADED the level 2 password could be changed.
- ➔ Should you forget either of these passwords, please contact REER which will provide an unlock file (when the unlock file is saved in the right directory the icon 🗝️ will appear on the toolbar). When the icon is activated, the password level 1 and level 2 are restored to their original values. This password is only given to the designer and can only be used once.

Password Change

To activate the PASSWORD Change use icon 🗝️, after connecting with Level 2 Password. A window appears (Figure 36) allowing the choice of the new password; insert the old and new passwords in the appropriate fields (max 8 characters). Click OK.

At the end of the operation disconnect to restart the system.

If MCM is present the new password is also saved in it.

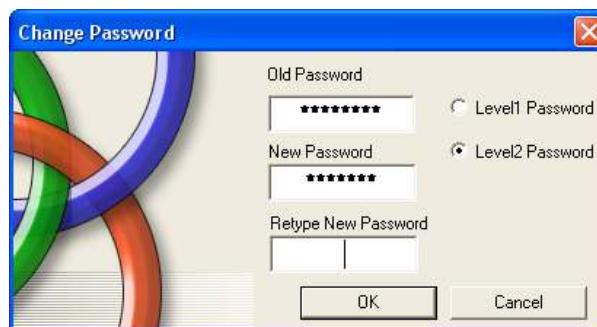

Figure 36

TESTING the system

After validating and uploading the project to the M1 and connecting all the safety devices, you must test the system to verify its correct operation.

This is done by forcing a change of status for each safety device connected to the MOSAIC to check that the status of the outputs actually changes. The following example is helpful for understanding the TEST procedure.

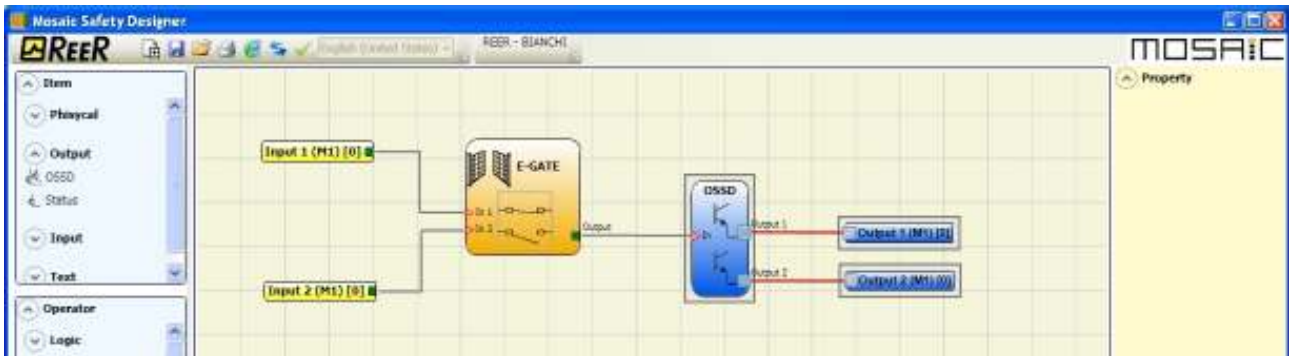
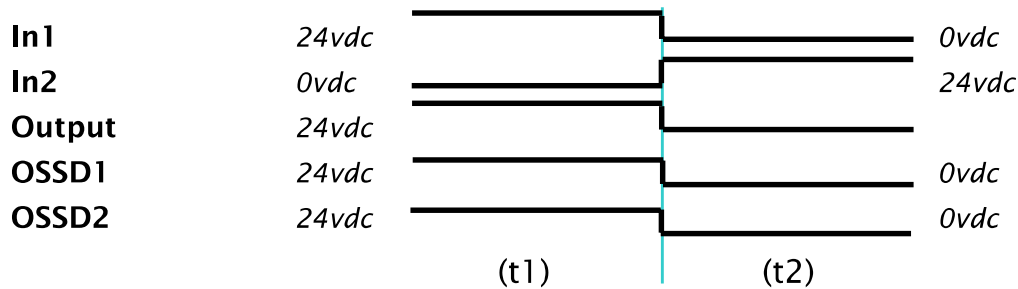

Figure 37

- (t1) In the normal operating condition (E-GATE closed) Input1 is closed, Input2 is open and the output of the E-GATE block is set to high logic level; in this mode the safety outputs (OSSD1/2) are active and the power supply to the relative terminals is 24VDC.
- (t2) When the E-GATE is **physically** opened, the condition of the inputs and thus of the outputs of the E-GATE block will change: (OUT= 0VDC--->24VDC); **the condition of the OSSD1-OSSD2 safety outputs will change from 24VDC to 0VDC.** If this change is detected the mobile E-GATE is connected correctly.



For the correct installation of each external sensor/component refer to their installation manual.
 This test must be performed for each safety component in the project.

OBJECT FUNCTION BLOCKS

OUTPUT OBJECTS

OSSD (safety outputs)

The OSSD semiconductor safety outputs require no maintenance, Output1 and Output2 supply 24Vdc if the input is 1 (TRUE), whereas they supply 0Vdc if the input is 0 (FALSE).

➔ Each pair of OSSD has an entrance on RESTART_FBK. This input must always be connected as described in paragraph RESTART_FBK.

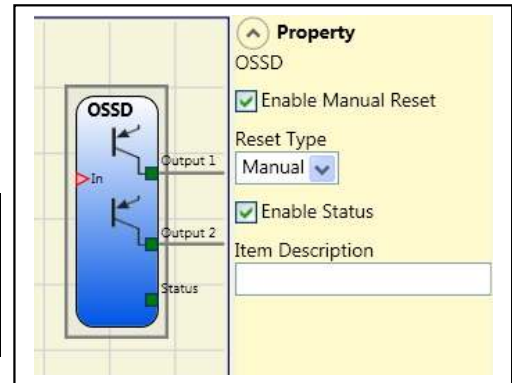

Parameters

Enabled reset: If selected this enables the request to reset each time the input signal falls. Otherwise, enabling of the output directly follows the input conditions.

There are two types of reset: Manual and Monitored. When Manual is selected the system only verifies the signal's transition from 0 to 1. If Monitored is selected the double transition from 0 to 1 and then back to 0 is verified.

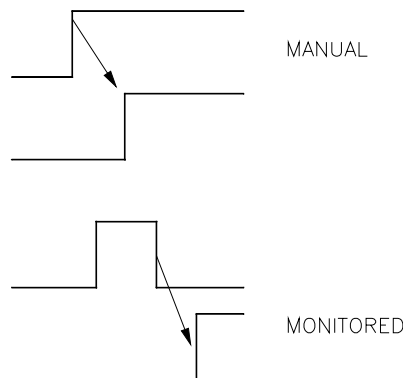

Enable status: If checked enables the connection of the current status of the OSSD with a STATUS.

STATUS (signal output)

STATUS output (NOT SAFETY OUTPUT) makes it possible to monitor any point on the diagram by connecting it to the input. The output returns 24Vdc if the input is 1 (TRUE), or 0Vdc if the input is 0 (FALSE).

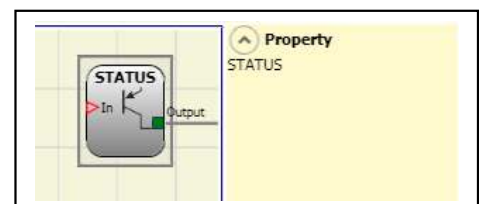

⚠ WARNING: The STATUS output is NOT a safety output.

INPUT OBJECTS

E-STOP (emergency stop)

E-STOP function block verifies an emergency stop device inputs status. If the emergency stop button has been pressed the output is 0 (FALSE). If not the output is 1 (TRUE).

Parameters

Input type:

- Single NC - allows connection of one-way emergency stops
- Double NC - allows connection of two-way emergency stops .

Enabled reset: If selected this enables the request to reset each time the emergency stop is activated. Otherwise, enabling of the output directly follows the input conditions.

There are two types of reset: Manual and Monitored. When Manual is selected the system only verifies the signal's transition from 0 to 1. If Monitored is selected the double transition from 0 to 1 and then back to 0 is verified.

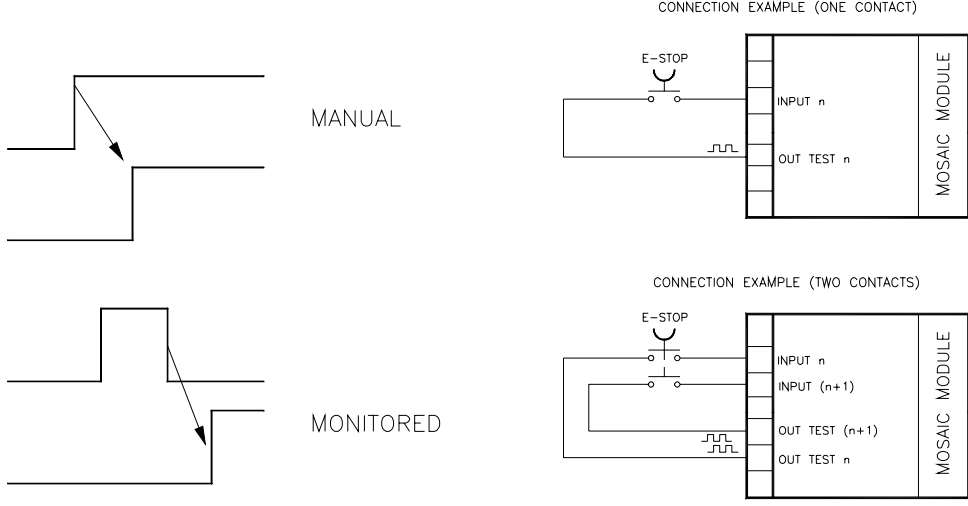
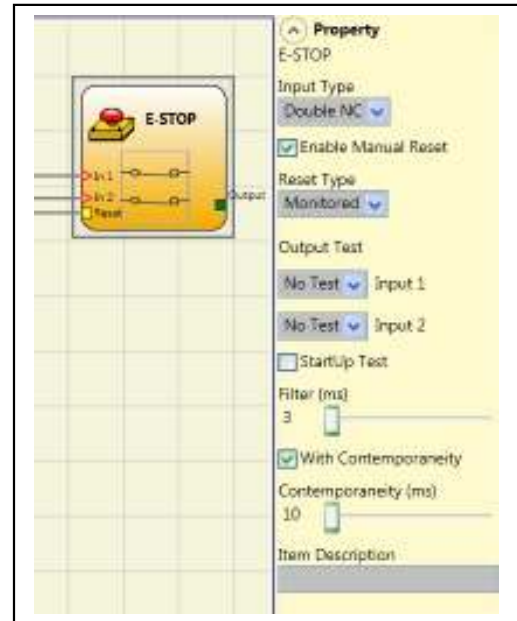

➔ **WARNING:** If the Enabled Reset is active, a consecutive Input have to be used. Example : Input 1 and Input 2 are used for the fuctional block, then Input 3 have to be used for the Reset Input.

Output test: This is used to select which test output signals are to be sent to the emergency stop (mushroom pushbutton). This additional test makes it possible to detect and manage any short-circuits between the lines. There is a choice of 4 possible test output signals, Test Output 1 ÷ Test Output 4.

Test at start-up: If selected this enables the test at start-up of the external component (emergency stop). This test is performed by pressing and releasing the pushbutton to run a complete function test and enable the output. This test is only requested at machine start-up (when the unit is switched on).

Filter (ms): This is used to filter the signals coming from the emergency stop. The filter can be configured to between 3 and 250 ms and eliminates any bouncing on the contacts. The length of the filter affects the calculation of the unit's total response time.

Concurrent enable: If selected this activates the test to verify concurrent switching of the signals coming from the emergency stop.

Concurrent (ms): This is only active if the previous parameter is enabled. It defines the maximum time (in msecs) between the switching of two different signals from the emergency stop.

Object description: This allows a description of the component's function to be entered. The text is displayed in the top part of the symbol.

E-GATE (safety gate device)

E-GATE function block verifies a mobile guard or safety gate device input status. If the mobile guard or safety gate is open, the output is 0 (FALSE). Otherwise the output is 1 (TRUE).

Parameters

Input type:

- Double NC – Allows connection of components with two NC contacts
- Double NC/NO – Allows connection of components with one NO contact and one NC.

Enable reset: If selected this enables the request to reset each time the mobile guard/safety gate is activated. Otherwise, enabling of the output directly follows the input conditions.

There are two types of reset: Manual and Monitored. When Manual is selected the system only verifies the signal's transition from 0 to 1. If Monitored is selected the double transition from 0 to 1 and then back to 0 is verified.

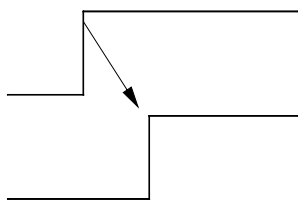
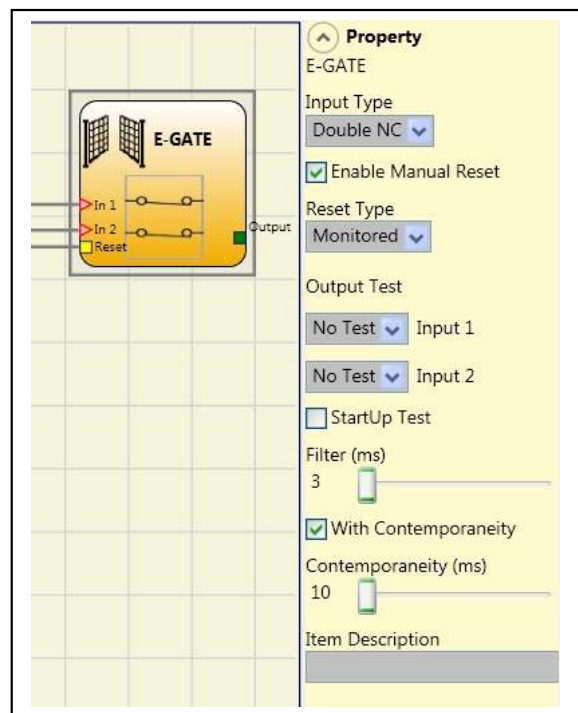

MANUAL

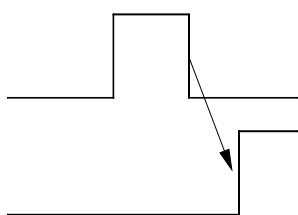

MONITORED

CONNECTION EXAMPLE (TWO CONTACTS)

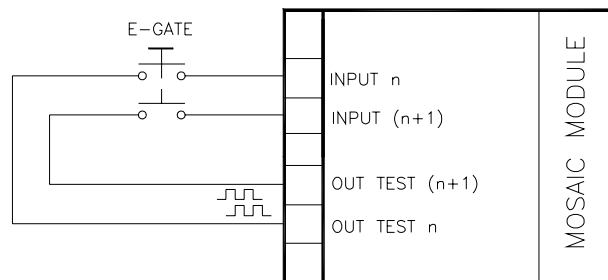

➔ **WARNING:** If the Enabled Reset is active, a consecutive Input have to be used. Example : Input 1 and Input 2 are used for the fuctional block, then Input 3 have to be used for the Reset Input.

Output test: This is used to select which test output signals are to be sent to the component contacts. This additional test makes it possible to detect and manage any short-circuits between the lines. There is a choice of 4 possible test output signals, Test Output 1 ÷ Test Output 4.

Test at start-up: If selected this enables the test at start-up of the external component. This test is performed by opening the mobile guard or safety gate to run a complete function test and enable the output. This test is only requested at machine start-up (when the unit is switched on).

Filter (ms): This is used to filter the signals coming from the external contacts. The filter can be configured to between 3 and 250 ms and eliminates any bouncing on the contacts. The length of the filter affects the calculation of the unit's total response time.

Concurrent enable: If selected this activates the test to verify concurrent switching of the signals coming from the external contacts.

Concurrent (ms): This is only active if the previous parameter is enabled. It defines the maximum time (in msec) between the switching of two different signals from the external contacts.

Object description: This allows a description of the component's function to be entered. The text is displayed in the top part of the symbol.

ENABLE (enable key)

ENABLE function block verifies a manual key device Input status. If the key is not turned the output is 0 (FALSE). Otherwise the output is 1 (TRUE).

Parameters

Input type

- Single NO - Allows connection of components with one NO contact;
- Double NO - Allows connection of components with two NO contacts.

Enable reset: If selected this enables the request to reset each time the command is activated. Otherwise, enabling of the output directly follows the input conditions.

There are two types of reset: Manual and Monitored. When Manual is selected the system only verifies the signal's transition from 0 to 1. If Monitored is selected the double transition from 0 to 1 and then back to 0 is verified.

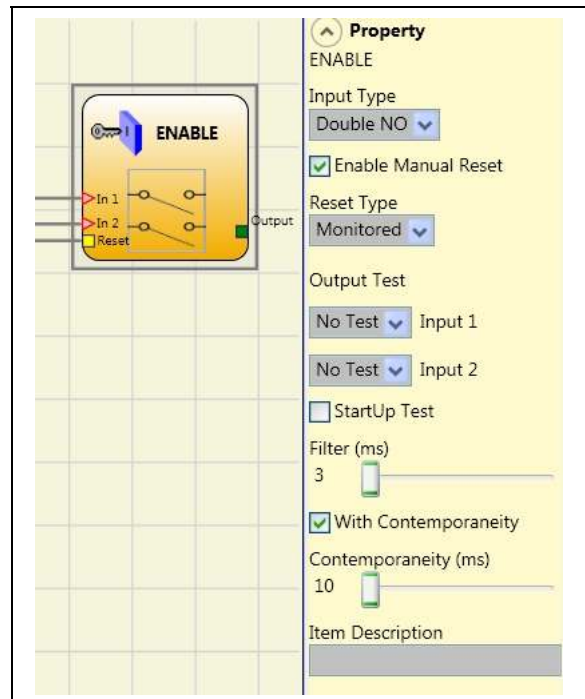

English

➔ **WARNING:** If the Enabled Reset is active, a consecutive Input have to be used. Example : Input 1 and Input 2 are used for the fuctional block, then Input 3 have to be used for the Reset Input.

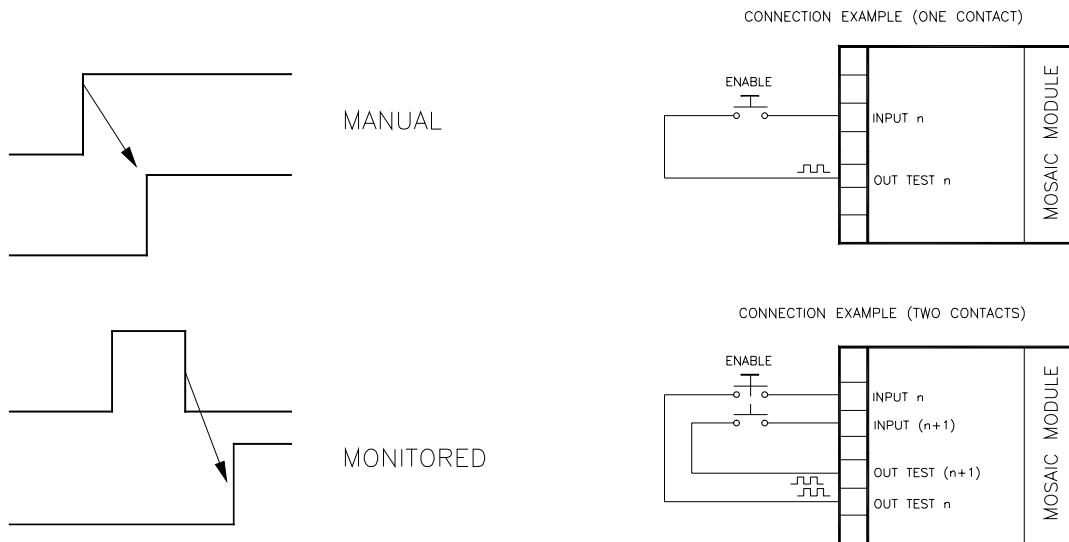

Output test: This is used to select which test output signals are to be sent to the component contacts. This additional test makes it possible to detect and manage any short-circuits between the lines. There is a choice of 4 possible test output signals, Test Output 1 ÷ Test Output 4.

Test at start-up: If selected this enables the test at start-up of the external component. This test is performed by opening and activating the enable key to run a complete function test and enable the output. This test is only requested at machine start-up (when the unit is switched on).

Filter (ms): This is used to filter the signals coming from the external contacts. The filter can be configured to between 3 and 250 ms and eliminates any bouncing on the contacts. The length of the filter affects the calculation of the unit's total response time.

Concurrent enable: If selected this activates the test to verify concurrent switching of the signals coming from the external contacts.

Concurrent (ms): This is only active if the previous parameter is enabled. It defines the maximum time (in msecs) between the switching of two different signals from the external contacts.

Object description: This allows a description of the component's function to be entered. The text is displayed in the top part of the symbol.

ESPE (optoelectronic safety light curtain / laser scanner)

ESPE function block verifies an optoelectronic safety light curtain (or laser scanner) inputs state. If the area protected by the light curtain is occupied, (light curtain outputs FALSE) the output is 0 (FALSE). Otherwise, with the area clear and outputs to 1 (TRUE) the output is 1 (TRUE).

Parameters

Enable reset: If selected this enables the request to reset each time the area protected by the safety light curtain is occupied. Otherwise, enabling of the output directly follows the input conditions.

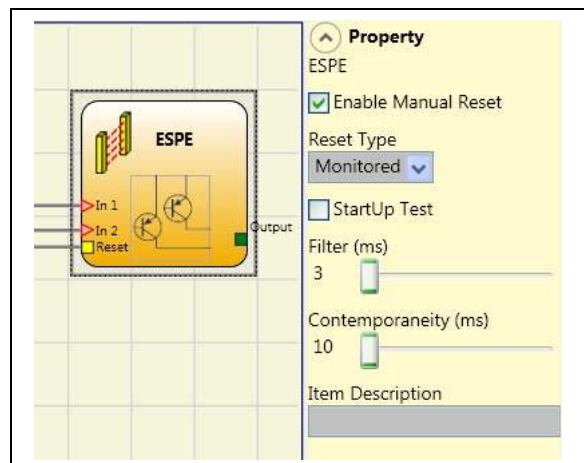

There are two types of reset: Manual and Monitored. When Manual is selected the system only verifies the signal's transition from 0 to 1. If Monitored is selected the double transition from 0 to 1 and then back to 0 is verified.

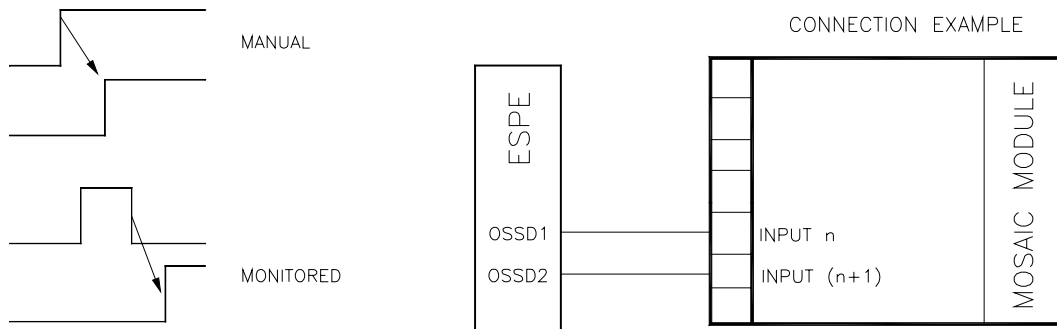

➔ **WARNING:** If the Enabled Reset is active, a consecutive Input have to be used. Example : Input 1 and Input 2 are used for the fuctional block, then Input 3 have to be used for the Reset Input.

OUT TEST signals cannot be used in case of safety static output ESPE because the control is carried out from the ESPE.

Test at start-up: If selected this enables the test at start-up of the safety light curtain. This test is performed by occupying and clearing the area protected by the safety light curtain to run a complete function test and enable the output. This test is only requested at machine start-up (when the unit is switched on).

Filter (ms): This is used to filter the signals coming from the safety light curtain. The filter can be configured to between 3 and 250 ms and eliminates any bouncing on the contacts. The length of the filter affects the calculation of the unit's total response time.

Concurrent enable: If selected this activates the test to verify concurrent switching of the signals coming from the safety light curtain.

Concurrent (ms): This is only active if the previous parameter is enabled. It defines the maximum time (in msec) between the switching of two different signals from the safety light curtain.

Object description: This allows a description of the component's function to be entered. The text is displayed in the top part of the symbol.

FOOTSWITCH (safety pedal)

The FOOTSWITCH function block verifies the status of the inputs of a safety pedal device. If the pedal is not pressed the output is 0 (FALSE). Otherwise the output is 1 (TRUE).

Parameters

Input type:

- Single NC - Allows connection of pedals with one NC contact
- Single NO - Allows connection of pedals with one NO contact.
- Double NC - Allows connection of pedals with two NC contacts
- Double NC/NO - Allows connection of pedals with one NO contact and one NC.

Enabled reset: If selected this enables the request to reset each time the safety pedal is activated. Otherwise, enabling of the output directly follows the input conditions.

There are two types of reset: Manual and Monitored. When Manual is selected the system only verifies the signal's transition from 0 to 1. If Monitored is selected the double transition from 0 to 1 and then back to 0 is verified.

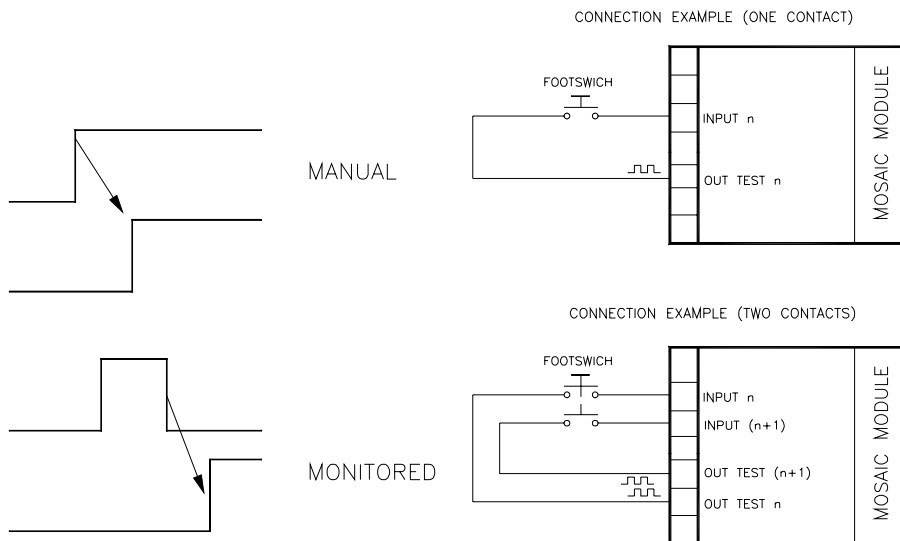
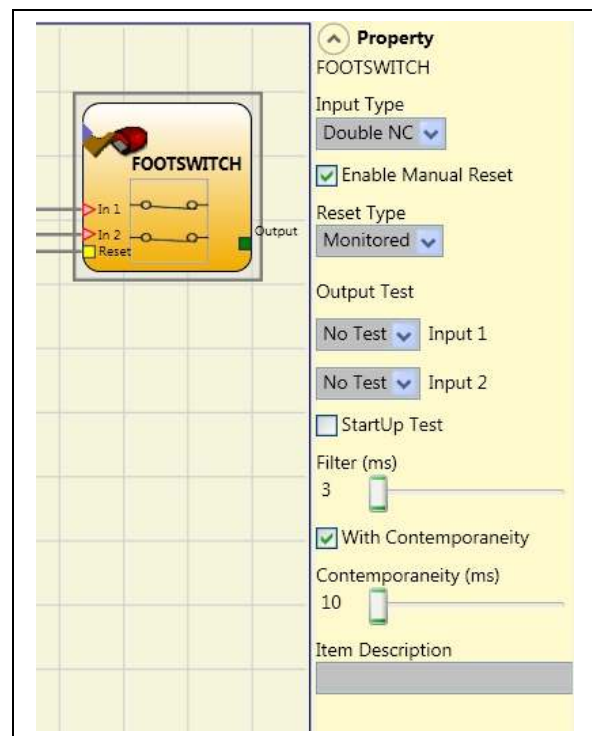

➔ **WARNING:** If the Enabled Reset is active, a consecutive Input have to be used. Example : Input 1 and Input 2 are used for the functional block, then Input 3 have to be used for the Reset Input.

Output test: This is used to select which test output signals are to be sent to the component contacts. This additional test makes it possible to detect and manage any short-circuits between the lines. There is a choice of 4 possible test output signals, Test Output 1 ÷ Test Output 4.

Test at start-up: If selected this enables the test at start-up of the external component. This test is performed by pressing and releasing the footswitch to run a complete function test and enable the output. This test is only requested at machine start-up (when the unit is switched on).

Filter (ms): This is used to filter the signals coming from the external contacts. The filter can be configured to between 3 and 250 ms and eliminates any bouncing on the contacts. The length of the filter affects the calculation of the unit's total response time.

Concurrent enable: If selected this activates the test to verify concurrent switching of the signals coming from the external contacts.

Concurrent (ms): This is only active if the previous parameter is enabled. It defines the maximum time (in msec) between the switching of two different signals from the external contacts.

Object description: This allows a description of the component's function to be entered. The text is displayed in the top part of the symbol.

MOD-SEL (safety selector)

The MOD-SEL function block verifies the status of the inputs from a mode selector (up to 4 inputs): If only one input is 1 (TRUE) the corresponding output is also 1 (TRUE). In all other cases, and thus when all inputs are 0 (FALSE) or more than one input is 1 (TRUE) all the outputs are 0 (FALSE)

Parameters

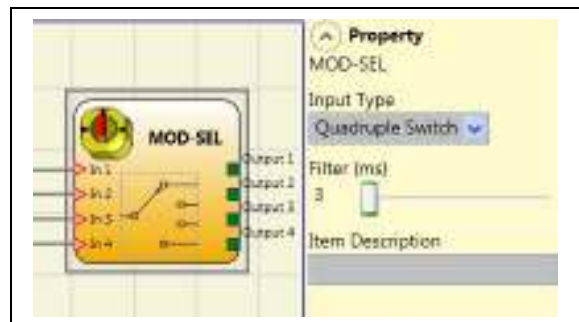

Input type:

- Double selector – Allows connection of two-way mode selectors.
- Triple selector – Allows connection of three-way mode selectors.
- Quadruple selector - Allows connection of four-way mode selectors.

Filter (ms): This is used to filter the signals coming from the mode selector. The filter can be configured to between 3 and 250 ms and eliminates any bouncing on the contacts. The length of the filter affects the calculation of the unit's total response time

Object description: This allows a description of the component's function to be entered. The text is displayed in the top part of the symbol.

PHOTOCELL (safety photocell)

The PHOTOCELL function block verifies the status of the inputs of an optoelectronic safety photocell. If the beam of the photocell is occupied (photocell output FALSE) the output is 0 (FALSE). Otherwise with the beam clear and an output of 1 (TRUE) the output is 1 (TRUE).

Parameters

Enabled reset: If selected this enables the request to reset each time safety photocell is activated. Otherwise, enabling of the output directly follows the input conditions.

There are two types of reset: Manual and Monitored. When Manual is selected the system only verifies the signal's transition from 0 to 1. If Monitored is selected the double transition from 0 to 1 and then back to 0 is verified.

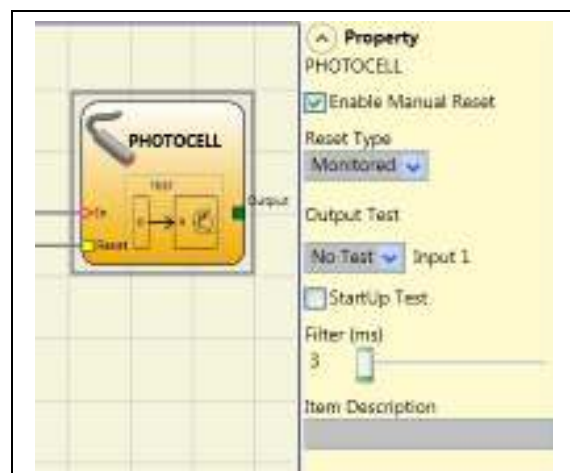

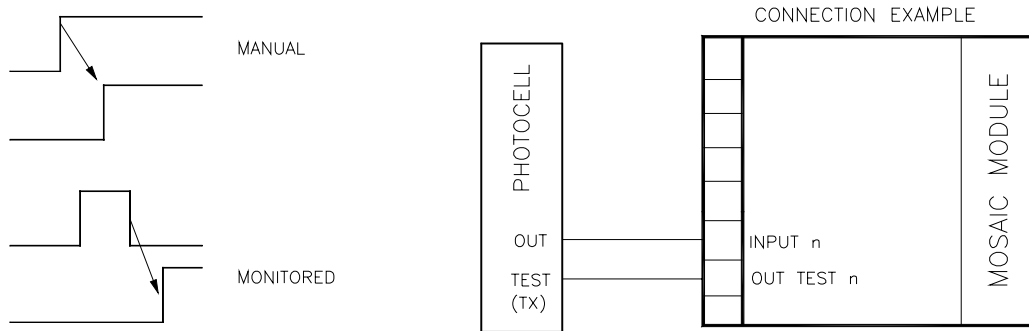

➔ **WARNING:** If the Enabled Reset is active, a consecutive Input have to be used. Example : Input 1 is used for the fuctional block, then Input 2 have to be used for the Reset Input.

Output test: This is used to select which test output are to be sent to the photocell test input. This additional test makes it possible to detect and manage any short-circuits between the lines. One test signal is mandatory and can be chosen among the four possible test output signals: Test Output 1 ÷ Test Output 4.

Test at start-up: If selected this enables the test at start-up of the external component. This test is performed by occupying and clearing the photocell to run a complete function test and enable the output. This test is only requested at machine start-up (when the unit is switched on).

Filter (ms): This is used to filter the signals coming from the external contacts. The filter can be configured to between 3 and 250 ms and eliminates any bouncing on the contacts. The length of the filter affects the calculation of the unit's total response time.

Object description: This allows a description of the component's function to be entered. The text is displayed in the top part of the symbol.

TWO-HAND (bimanual control)

The TWO HAND function block verifies the status of the inputs of a two hand control switch. Only if both the press-buttons are pressed within 500 msec the output is 1 (TRUE). Otherwise the output is 0 (FALSE).

Input type:

- Double NO - Allows connection of two-hand switch with one NO contact for each button.
- Quadruple NC-NO - Allows connection of two-hand switch with a double NO/NC contact for each button.

Output test: This is used to select which test output signals are to be sent to the component contacts. This additional test makes it possible to detect and manage any short-circuits between the lines. There is a choice of 4 possible test output signals, Test Output 1 ÷ Test Output 4.

Test at start-up: If selected this enables the test at start-up of the external component. This test is performed by pressing the two buttons (within 500 msec) and releasing them to run a complete function test and enable the output. This test is only requested at machine start-up (when the unit is switched on).

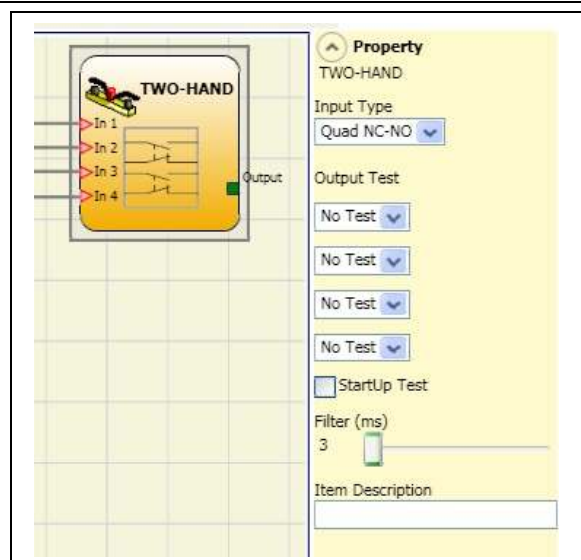

Filter (ms): This is used to filter the signals coming from the mode selector. The filter can be configured to between 3 and 250 ms and eliminates any bouncing on the contacts. The length of the filter affects the calculation of the unit's total response time

Item description: This allows a description of the component's function to be entered. The text is displayed in the top part of the symbol.

SENSOR

The SENSOR function block verifies the status of the input of a sensor (not a safety sensor). If the beam of the sensor is occupied (sensor output FALSE) the output is 0 (FALSE). Otherwise, with the beam clear and an output of 1 (TRUE) then the output is 1 (TRUE).

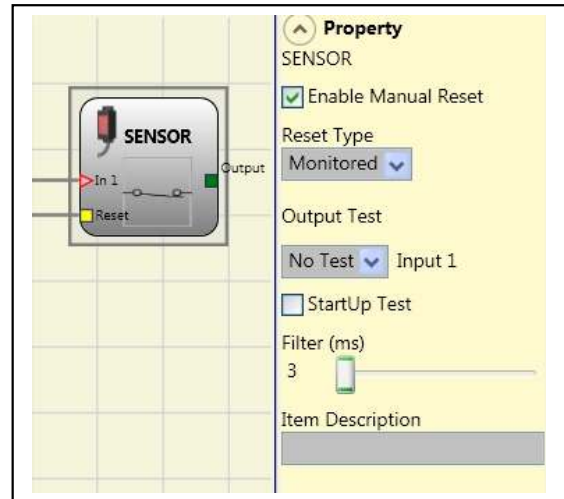

Parameters

Enabled reset: If selected this enables the request to reset each time the area protected by the sensor is occupied. Otherwise, enabling of the output directly follows the input conditions. There are two types of reset: Manual and Monitored. When Manual is selected the system only verifies the signal's transition from 0 to 1. If Monitored is selected the double transition from 0 to 1 and then back to 0 is verified.

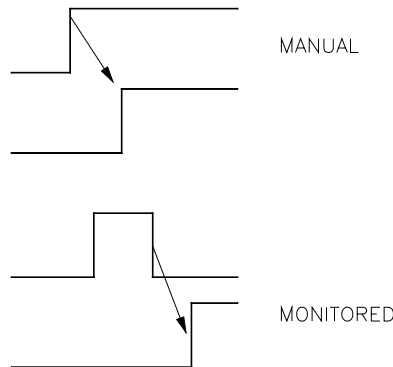

➔ **WARNING:** If the Enabled Reset is active, a consecutive Input have to be used. Example : Input 1 is used for the fuctional block, then Input 2 have to be used for the Reset Input.

Output test: This is used to select which test output signals are to be sent to the sensor. This additional test makes it possible to detect and manage any short-circuits between the lines. There is a choice of 4 possible test output signals, Test Output 1 ÷ Test Output 4.

Test at start-up: If selected this enables the test at start-up of the sensor. This test is performed by occupying and clearing the area protected by the sensor to run a complete function test and enable the output. This test is only requested at machine start-up (when the unit is switched on).

Filter (ms): This is used to filter the signals coming from the sensor. The filter can be configured to between 3 and 250 ms and eliminates any bouncing on the contacts. The length of the filter affects the calculation of the unit's total response time.

Object description: This allows a description of the component's function to be entered. The text is displayed in the top part of the symbol.

S-MAT (safety mat)

The S-MAT function block verifies the status of the inputs of a safety mat. If a person stands on the mat the output is 0 (FALSE). Otherwise, with the mat clear, the output is 1 (TRUE).

Parameters

Enabled reset: If selected this enables the request to reset each time the mobile guard/safety gate is activated. Otherwise, enabling of the output directly follows the input conditions.

There are two types of reset: Manual and Monitored. When Manual is selected the system only verifies the signal's transition from 0 to 1. If Monitored is selected the double transition from 0 to 1 and then back to 0 is verified.

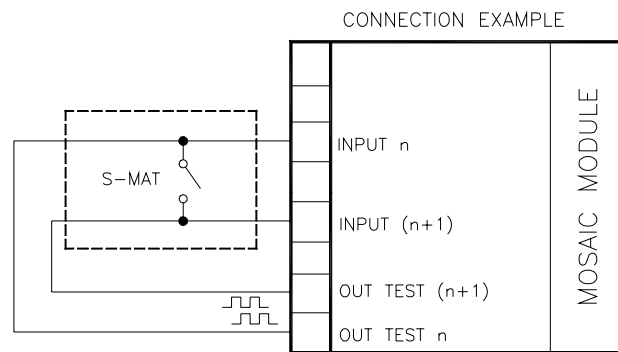
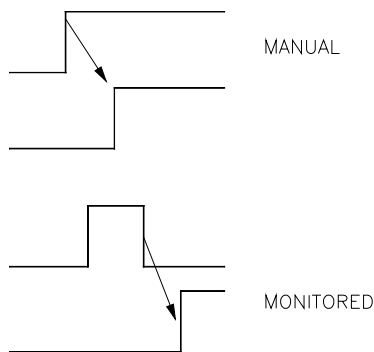
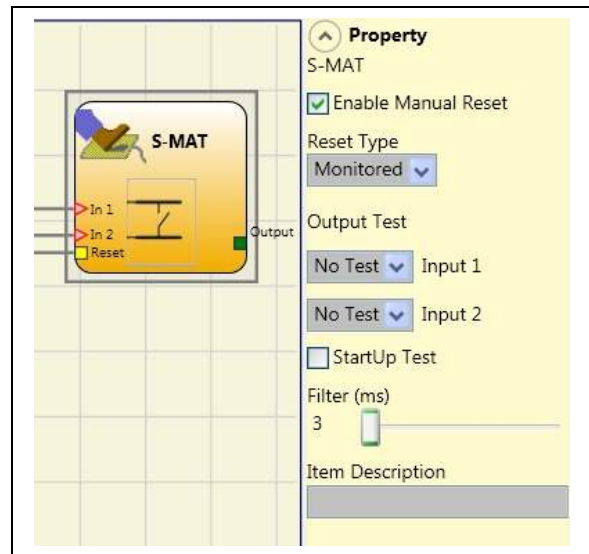

- ➔ If the Enabled Reset is active, a consecutive Input have to be used. Example : Input 1 and Input 2 are used for the functional block, then Input 3 have to be used for the Reset Input.
- ➔ Each output OUT TEST can be connected to only one input S-MAT (it is not allowed parallel connection of 2 inputs).
- ➔ The function block S-MAT can not be used with 2-wire components and termination resistance.

Output test: This is used to select which test output signals are to be sent to the mat contact. This additional test makes it possible to detect and manage any short-circuits between the lines. Test signals are mandatory and must be chosen between two possible configurations: Test Output 1/Test Output 2 or Test Output 3/Test Output 4.

Test at start-up: If selected this enables the test at start-up of the external component. This test is performed by pressing and releasing the safety mat to run a complete function test and enable the output. This test is only requested at machine start-up (when the unit is switched on).

Filter (ms): This is used to filter the signals coming from the external contacts. The filter can be configured to between 3 and 250 ms and eliminates any bouncing on the contacts. The length of the filter affects the calculation of the unit's total response time.

Object description: This allows a description of the component's function to be entered. The text is displayed in the top part of the symbol.

SWITCH

SWITCH function block verifies the input status of a pushbutton or switch (NOT SAFETY SWITCHES). If the pushbutton is pressed the output is 1 (TRUE). Otherwise, the output is 0 (FALSE).

Parameters

Enabled reset: If selected this enables the request to reset each time the area protected by the safety light curtain is occupied. Otherwise, enabling of the output directly follows the input conditions.

There are two types of reset: Manual and Monitored. When Manual is selected the system only verifies the signal's transition from 0 to 1. If Monitored is selected the double transition from 0 to 1 and then back to 0 is verified.

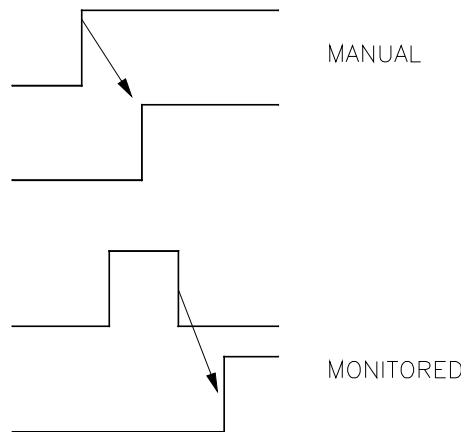
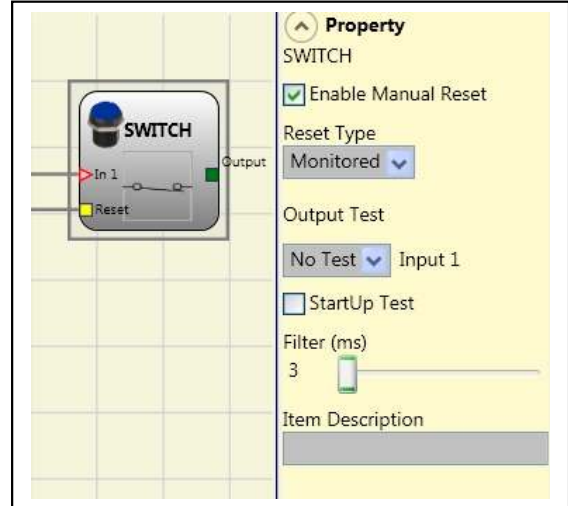

➔ **WARNING:** If the Enabled Reset is active, a consecutive Input have to be used. Example : Input 1 is used for the fuctional block, then Input 2 have to be used for the Reset Input.

Output test: This is used to select which test output signals are to be sent to the switch. This additional test makes it possible to detect and manage any short-circuits between the lines. There is a choice of 4 possible test output signals, Test Output 1 ÷ Test Output 4.

Test at start-up: If selected this enables the test at start-up of the switch. This test is performed by opening and closing the switch contact to run a complete function test and enable the output. This test is only requested at machine start-up (when the unit is switched on).

Filter (ms): This is used to filter the signals coming from the switch. The filter can be configured to between 3 and 250ms and eliminates any bouncing on the contacts. The length of the filter affects the calculation of the unit's total response time.

Object description: This allows a description of the component's function to be entered. The text is displayed in the top part of the symbol.

COMMENTS

This allows a description to be entered and placed in any point of the diagram.



TITLE

Automatically adds the name of the manufacturer, the designer, the project name and the CRC.



OPERATOR FUNCTION BLOCKS

All the input of these operators could be inverted (logical NOT). It could be done clicking with the right mouse key on the input to be inverted. A little circle will be showed on the inverted input. To cancel the inversion, simply click another time on the same input pin.

➔ The maximum number of user blocks is 32.

LOGICAL OPERATORS

AND

Logical AND returns an output of 1 (TRUE) if all the inputs are 1 (TRUE).

In ₁	In ₂	In _x	Out
0	0	0	0
1	0	0	0
0	1	0	0
1	1	0	0
0	0	1	0
1	0	1	0
0	1	1	0
1	1	1	1

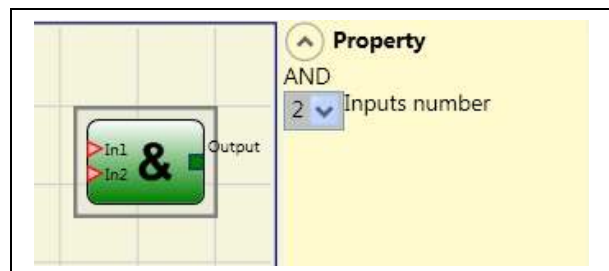

Parameters

Number of inputs: this is used to set between 2 and 8 inputs.

NAND

Logical NAND returns an output of 0 (FALSE) if all the inputs are 1 (TRUE).

In ₁	In ₂	In _x	Out
0	0	0	1
1	0	0	1
0	1	0	1
1	1	0	1
0	0	1	1
1	0	1	1
0	1	1	1
1	1	1	0

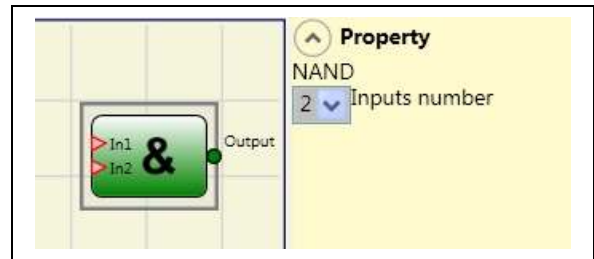

Parameters

Number of inputs: this is used to set between 2 and 8 inputs.

NOT

Logical NOT inverts the logical status of the input.

In	Out
0	1
1	0

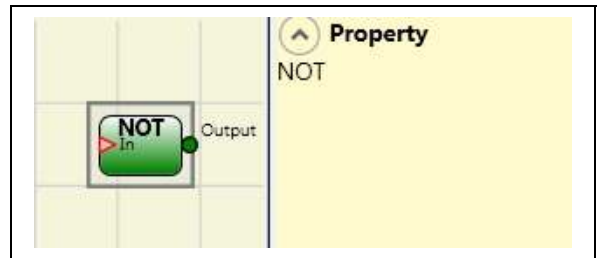

OR

Logical OR returns an output of 1 (TRUE) if at least one of the inputs is 1 (TRUE).

In ₁	In ₂	In _x	Out
0	0	0	0
1	0	0	1
0	1	0	1
1	1	0	1
0	0	1	1
1	0	1	1
0	1	1	1
1	1	1	1

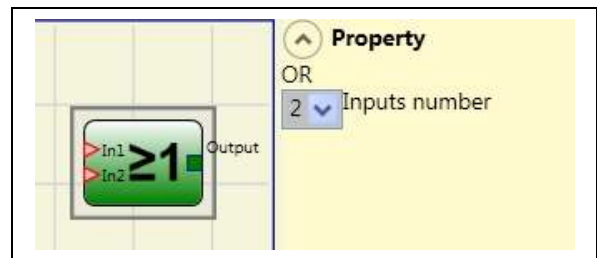

Parameters

Number of inputs: this is used to set between 2 and 8 inputs.

NOR

Logical NOR returns an output of 0 (FALSE) if at least one of the inputs is 1 (TRUE).

In ₁	In ₂	In _x	Out
0	0	0	1
1	0	0	0
0	1	0	0
1	1	0	0
0	0	1	0
1	0	1	0
0	1	1	0
1	1	1	0

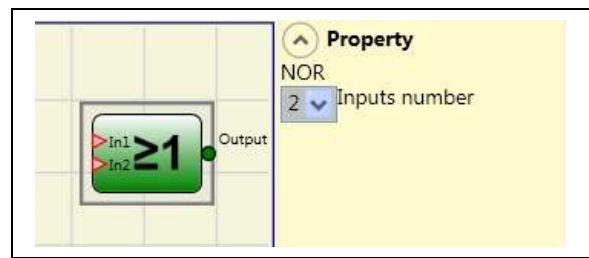

Parameters

Number of inputs: this is used to set between 2 and 8 inputs.

XOR

Logical XOR returns an output 0 (FALSE) if the input's number at 1 (TRUE) is even or the inputs are all 0 (FALSE).

In ₁	In ₂	In _x	Out
0	0	0	0
1	0	0	1
0	1	0	1
1	1	0	0
0	0	1	1
1	0	1	0
0	1	1	0
1	1	1	1

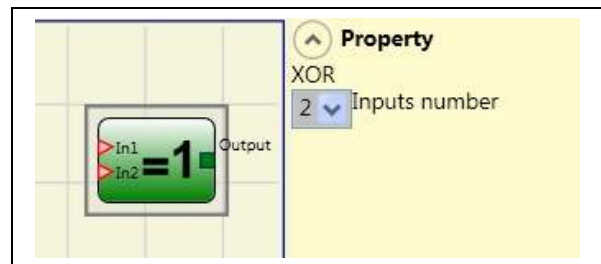

Parameters

Number of inputs: this is used to set between 2 and 8 inputs.

XNOR

Logical XNOR returns an output 1 (TRUE) if the input's number at 1 (TRUE) is even or the inputs are all 0 (FALSE).

In ₁	In ₂	In _x	Out
0	0	0	1
1	0	0	0
0	1	0	0
1	1	0	1
0	0	1	0
1	0	1	1
0	1	1	1
1	1	1	0

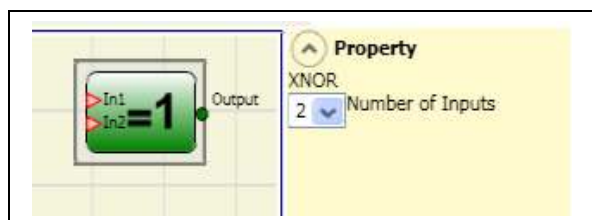

Parameters

Number of inputs: this is used to set between 2 and 8 inputs.

MULTIPLEXER

Logical MULTIPLEXER forwards the signal of the inputs to the output according to the Sel selection. If the SEL1÷SEL4 have only one bit set, the selected *In n* is connected to the Output. If the SEL inputs are:

- more than one = 1 (TRUE)
- none = 1 (TRUE)

the output is set to 0 (FALSE) independently from the *In n* values.

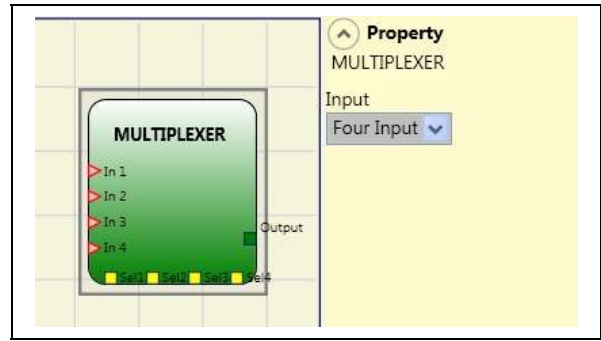

Parameters

Number of inputs: this is used to set between 2 and 4 inputs.

MEMORY OPERATORS

MEMORY operators can be used if you decide to save any data (TRUE or FALSE) from other project components.

Status changes are performed according to the truth tables shown for each operator.

D FLIP FLOP (max number = 8)

The D FLIP FLOP operator saves the previously set status on output Q according to the following truth table.

Preset	Clear	Ck	D	Q
1	0	X	X	1
0	1	X	X	0
1	1	X	X	0
0	0	L	X	Keep memory
0	0	Rising edge	1	1
0	0	Rising edge	0	0



Parameters

Preset: If selected enables output Q to be set to 1 (TRUE).

Clear: If selected enables the saving process to be reset.

SR FLIP FLOP

SR FLIP FLOP operator brings output Q at 1 with Set, 0 with Reset.
See the following truth table.

SET	RESET	Q
0	0	Keep memory
0	1	0
1	0	1
1	1	0

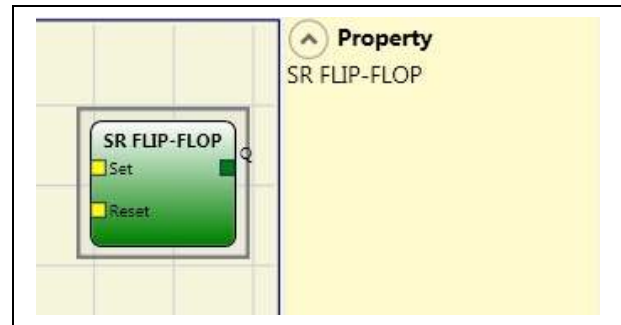

USER RESTART MANUAL (max number = 8 with RESTART MONITORED)

The USER RESTART MANUAL operator saves the restart signal according to the following truth table.

Clear	Restart	In	Q
1	X	X	0
X	X	0	0
0	L	1	Keep memory
0	Rising edge	1	1
0	Falling edge	1	Keep memory

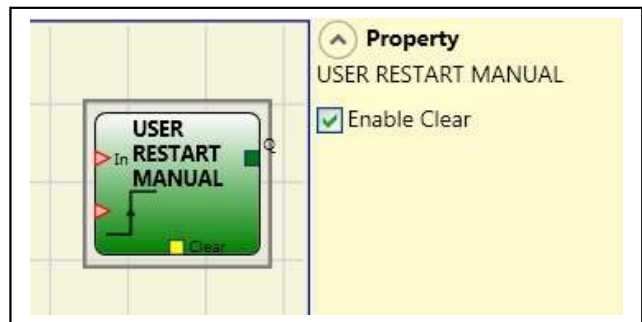

Parameters

Clear enable: If selected enables the saving process to be reset.

USER RESTART MONITORED (max number = 8 with RESTART MANUAL)

The USER RESTART MONITORED operator is used to save the restart signal according to the following truth table.

Clear	Restart	In	Q
1	X	X	0
X	X	0	0
0	L	1	Keep memory
0	Rising edge	1	Keep memory
0		1	1



Parameters

Clear enable: If selected enables the saving process to be reset.

COUNTER OPERATORS

COUNTER operator is a pulse counter that sets output Q to 1 (TRUE) as soon as the desired count is reached.

COUNTER (max number = 8).

The operator COUNTER is a pulse counter. There are 3 operating modes:

- 1) AUTOMATIC
- 2) MANUAL
- 3) AUTOMATIC + MANUAL

- 1) The counter generates a pulse duration equal to the system response time as soon as the set count is reached. If the CLEAR pin is not enabled this is the default mode.
- 2) The counter leads to 1 (TRUE) the output Q as soon as it reaches the set count. The output Q goes to 0 (FALSE) when the signal CLEAR is activated.
- 3) The counter generates a pulse duration equal to the system response time as soon as the set count is reached. If the CLEAR signal is activated, the internal count goes back to 0.

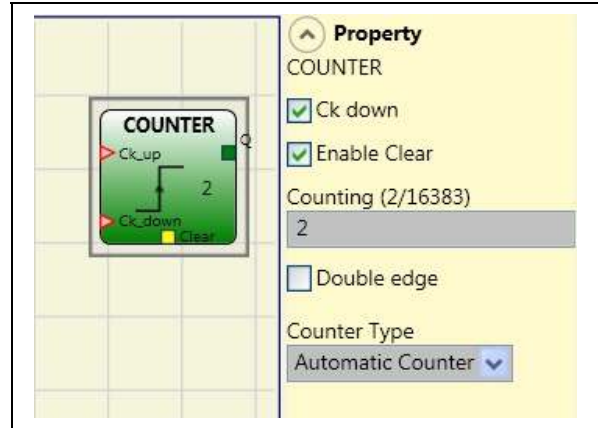

Parameters

Clear Enable: If selected this enables the request to clear in order to restart the counter setting output Q to 0 (FALSE). It also offers the possibility of enabling or not enabling (*Automatic Enable*) automatic operation with manual reset.

If this is not selected operation is automatic. Once the set count is reached output Q is set to 1 (TRUE) and stays in this condition for two internal cycles after which it is resetted.

Ck down: Enables counting down.

Two-way: If selected it enables counting on both the rising and falling edges.

TIMER OPERATORS (max number = 8)

TIMER operators allow you to generate a signal (TRUE or FALSE) for a user-definable period.

CLOCKING

CLOCKING operator generates a clock signal output with the desired period if the input In is 1 (TRUE).

Parameters

Time: The period can be set to between **10 ms** and **1093.3 s**.



MONOSTABLE

The MONOSTABLE operator generates a level 1 (TRUE) output activated by the rising edge of the input and remains in this condition for the set time.

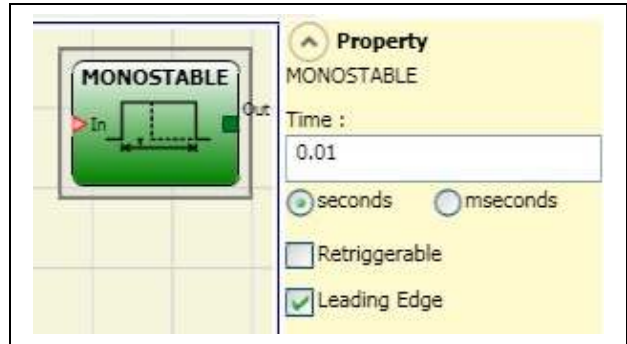

Parameters

Time: The delay can be set to between 10 ms and 1093.3 s.

Rising edge: If selected, the output is set to 1 (TRUE) on the input signal's rising edge where it remains for the set time, which can be extended for as long as the input stays at 1 (TRUE).

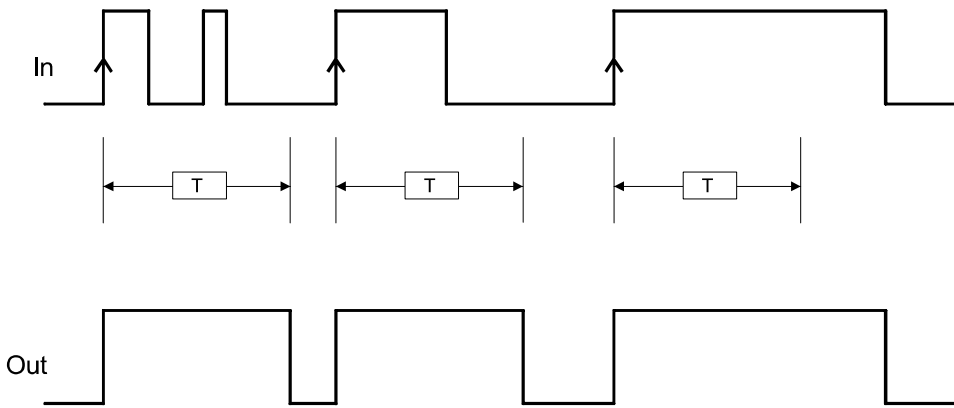

If not selected the logic is inverted, the output is set to 0 (FALSE) on the input signal's falling edge, where it remains for the set time, which can be extended for as long as the input stays at 0 (FALSE).

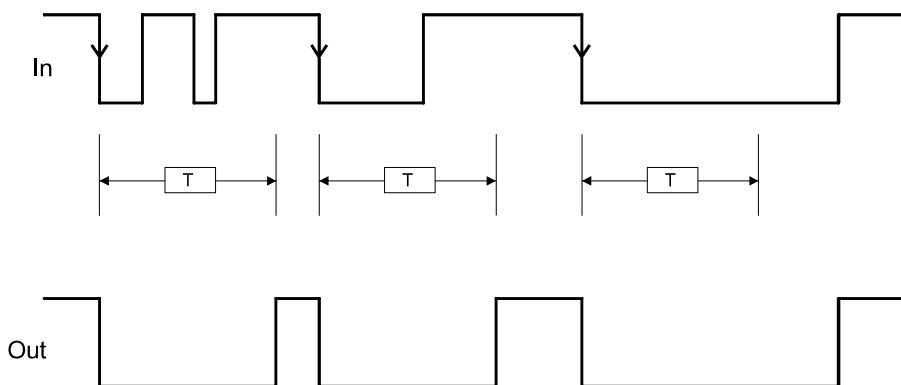

Retriggerable: If selected the time is reset each time the input status changes.

PASSING MAKE CONTACT

In the PASSING MAKE CONTACT operator the output follows the signal on the input. However, if this is 1 (TRUE) for longer than the set time, the output changes to 0 (FALSE). When there is an input falling edge, the timer is cleared.

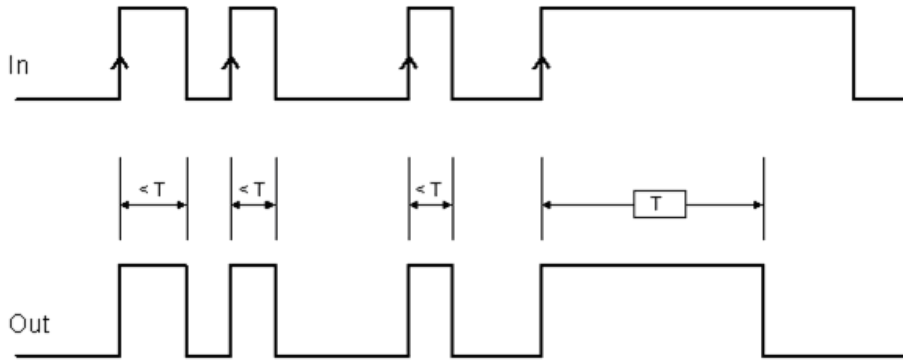
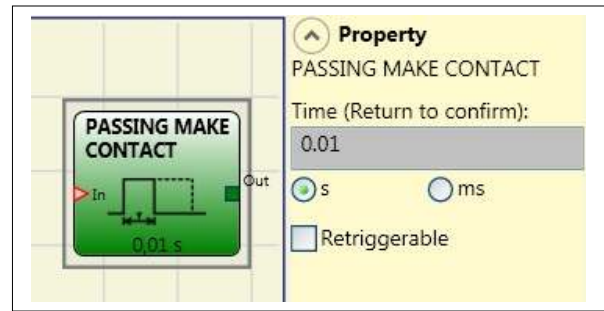

Parameters

Time: The delay can be set to between **10 ms** and **1093.3 s**.

Retriggerable: If selected the time is not reset when there is an input falling edge. The output stays 1 (TRUE) for all the selected time. When there is a new input rising edge, the timer restart again.

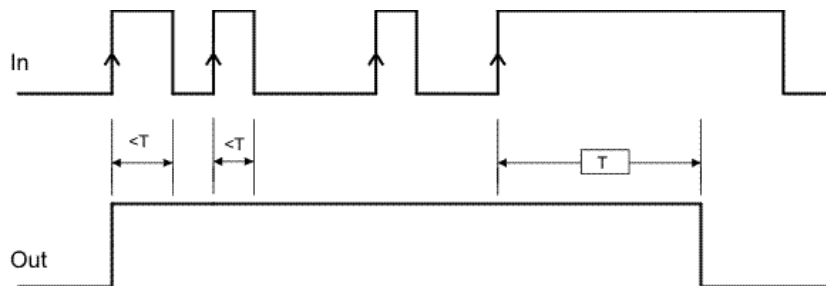

DELAY

DELAY operator applies a delay to a signal by setting the output to 1 (TRUE) after the set time, against a change in the level of the input signal.

Parameters

Time: The delay can be set to between **10 ms and 1093.3 s**.

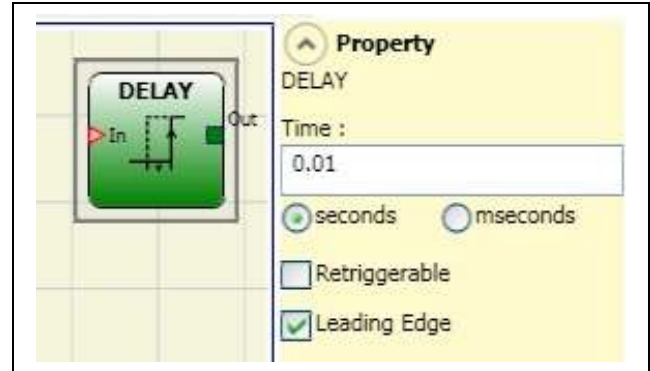

Rising edge: If selected, the delay starts on the input signal's rising edge at the end of which the output changes to 1 (TRUE) if the input is 1 (TRUE) where it remains for as long as the input stays at 1 (TRUE).

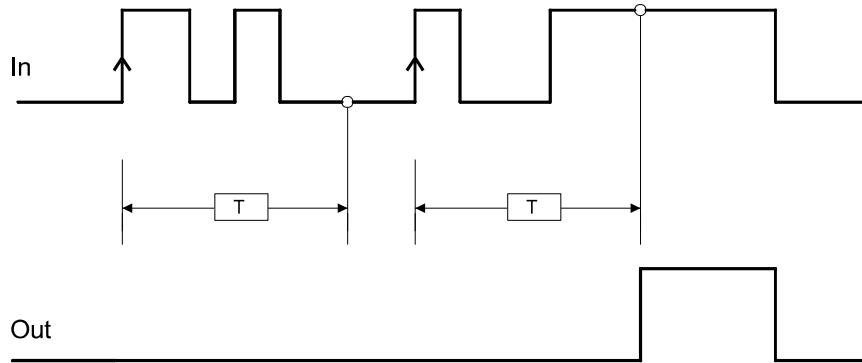

If not selected the logic is inverted, the output is set to 1 (TRUE) on the input signal's falling edge, the delay starts on the input signal's falling edge, at the end of the set time the output changes to 0 (FALSE) if the input is 0 (FALSE) otherwise it remains 1 TRUE.

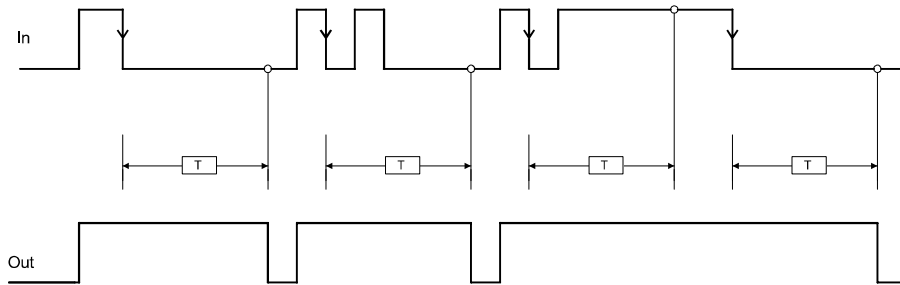

Retriggerable: If selected the time is reset each time the input status changes.

MUTING OPERATORS (max number = 4)

"Concurrent" MUTING

The MUTING operator with "Concurrent" logic performs muting of the input signal through sensor inputs S1, S2, S3 and S4.

➔ Preliminary condition: The Muting cycle can only start if all the sensors are 0 (FALSE) and inputs are 1 (TRUE) (barrier free).

Parameters

Timeout (sec): Sets the time, between 10 secs and unlimited, within which the Muting cycle must end. If the cycle is not complete at the end of this time, Muting is immediately discontinued.

Enable: If selected it enables the possibility of enabling or not enabling the Muting function. Otherwise the Muting function is always enabled.

There are two Enable modes: Enable/Disable and Enable Only. If Enable/Disable is selected the Muting cycle cannot start if Enable is fixed at 1 (TRUE) or 0 (FALSE) but is only activated with a rising edge. To disable muting, set Enable to 0 (FALSE). In this mode the falling edge disables Muting regardless of the condition. If Enable Only is selected Muting cannot be disabled but Enable must be set to 0 (FALSE) in order to enable a new rising edge for the next Muting cycle.

Direction: The order in which the sensors are occupied can be set. If set to BIDIR they can be occupied in both directions, from S1&S2 to S3&S4 and from S3&S4 to S1&S2, if set to UP they can be occupied from S1&S2 to S3&S4 and if set to DOWN from S3&S4 to S1&S2.

Muting Close: There are two types, CURTAIN and SENSOR. If you select CURTAIN muting closes when the input signal rises, if you select SENSOR it closes when the third sensor has been cleared.

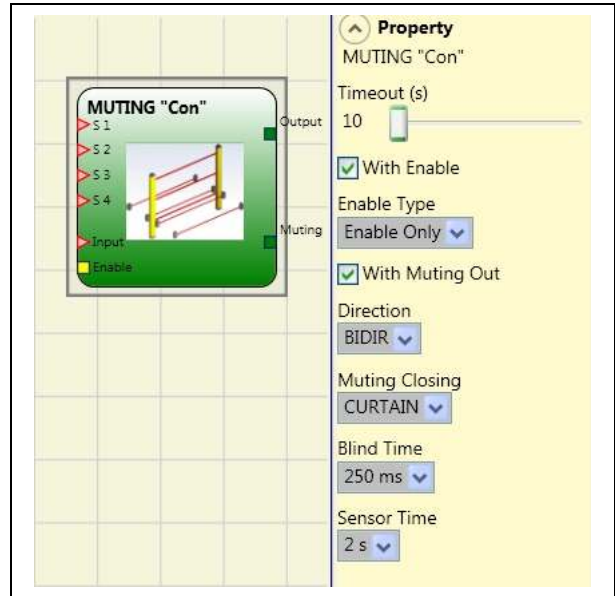

Select CURTAIN

S1	S2	Input	S3	S4	Muting
0	0	1	0	0	0
1	0	1	0	0	0
1	1	1	0	0	1
1	1	X	0	0	1
1	1	X	1	1	1
0	0	0	1	1	1
0	0	1	1	1	0
0	0	1	0	0	0

Select SENSOR

S1	S2	Input	S3	S4	Muting
0	0	1	0	0	0
1	0	1	0	0	0
1	1	1	0	0	1
1	1	X	0	0	1
1	1	X	1	1	1
0	0	0	1	1	1
0	0	1	1	1	1
0	0	1	0	1	0
0	0	1	0	0	0

Blind Time: *Only with Muting Close=Curtain*, blind time is enabled if you know that after the complete transition of the pallet (muting cycle close) some protruding objects could still occupy the light curtain and send the input to 0 (FALSE). During blind time the input remains 1 (TRUE). Blind Time can range from 250 msecs to 1 second.

Sensor time: A difference of between 2 and 5 seconds can be set for activating the sensors.

MUTING “L”

The MUTING operator with “L” logic performs muting of the input signal through sensor inputs S1 and S2.

➔ Preliminary condition: The Muting cycle can only start if S1 and S2 are 0 (FALSE) and the inputs are 1 (TRUE) (barrier free).

Parameters

Timeout (sec): Sets the time, between 10 secs and unlimited, within which the Muting cycle must end. If the cycle is not complete at the end of this time, Muting is immediately discontinued.

Enable: If selected it enables the possibility of enabling or not enabling the Muting function. Otherwise the Muting function is always enabled.

There are two Enable modes: Enable/Disable and Enable Only. If Enable/Disable is selected the Muting cycle cannot start if Enable is fixed at 1 (TRUE) or 0 (FALSE) but is only activated with a rising edge. To disable muting, set Enable to 0 (FALSE). In this mode the falling edge disables Muting regardless of the condition. If Enable Only is selected Muting cannot be disabled but Enable must be set to 0 (FALSE) in order to enable a new rising edge for the next Muting cycle.

Sensor time: A difference of between 2 and 5 seconds can be set for activating the sensors.

End of Muting time: Sets the muting falling time, from 2.5 to 6 seconds, after the second sensor has been cleared.

Blind Time: enabled if you know that after the complete transition of the pallet (muting cycle close) some protruding objects could still occupy the light curtain and send the input to 0 (FALSE). During blind time the input remains 1 (TRUE). Blind Time can range from 250 msecs to 1 second.

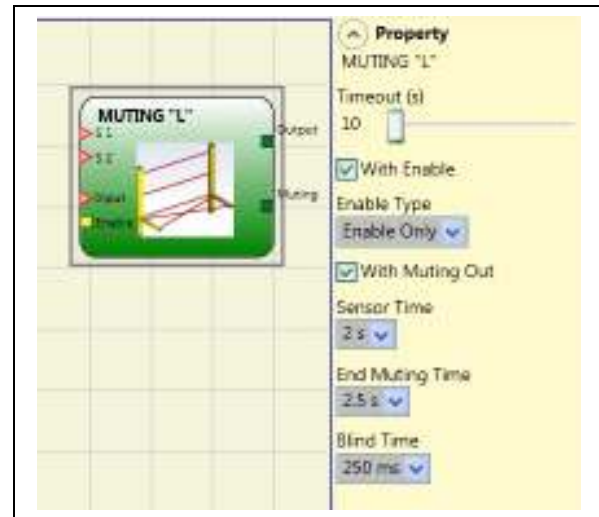

"Sequential" MUTING

The MUTING operator with "Sequential" logic performs muting of the input signal through sensor inputs S1, S2, S3 and S4.

➔ Preliminary condition: The Muting cycle can only start if all the sensors are 0 (FALSE) and the inputs are 1 (TRUE) (barrier free).

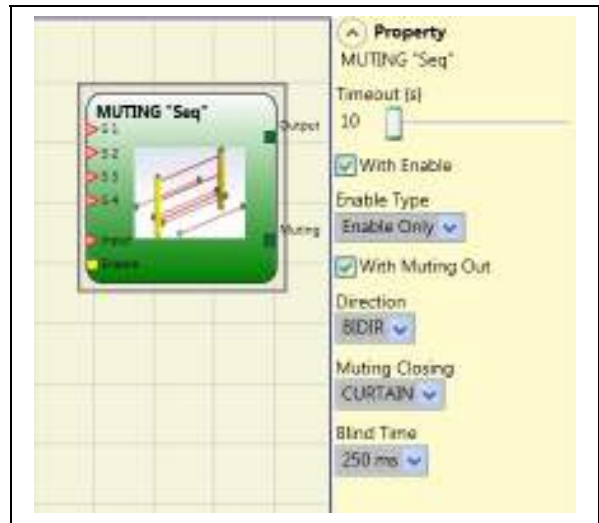

Parameters

Timeout (sec): Sets the time, between 10 secs and unlimited, within which the Muting cycle must end. If the cycle is not complete at the end of this time, Muting is immediately discontinued.

Enable: If selected it enables the possibility of enabling or not enabling the Muting function. Otherwise the Muting function is always enabled.

There are two Enable modes: Enable/Disable and Enable Only. If Enable/Disable is selected the Muting cycle cannot start if Enable is fixed at 1 (TRUE) or 0 (FALSE) but is only activated with a rising edge. To disable muting, set Enable to 0 (FALSE). In this mode the falling edge disables Muting regardless of the condition. If Enable Only is selected Muting cannot be disabled but Enable must be set to 0 (FALSE) in order to enable a new rising edge for the next Muting cycle.

Direction: The order in which the sensors are occupied can be set. If set to BIDIR they can be occupied in both directions, from S1 to S4 and from S4 to S1, if set to UP they can be occupied from S1 to S4 and if set to DOWN from S4 to S1.

Muting Close: There are two types, CURTAIN and SENSOR. If you select CURTAIN muting closes when the input signal rises, if you select SENSOR it closes when the last sensor has been cleared.

Select CURTAIN

S1	S2	Input	S3	S4	Muting
0	0	1	0	0	0
1	0	1	0	0	0
1	1	1	0	0	1
1	1	X	0	0	1
1	1	X	1	0	1
1	1	X	1	1	1
0	1	X	1	1	1
0	0	0	1	1	1
0	0	1	1	1	0
0	0	1	0	1	0
0	0	1	0	0	0

Select SENSOR

S1	S2	Input	S3	S4	Muting
0	0	1	0	0	0
1	0	1	0	0	0
1	1	1	0	0	1
1	1	X	0	0	1
1	1	X	1	0	1
1	1	X	1	1	1
0	1	X	1	1	1
0	0	0	1	1	1
0	0	1	1	1	1
0	0	1	0	1	0
0	0	1	0	0	0

Blind Time: Only with Muting Close=Curtain, blind time is enabled if you know that after the complete transition of the pallet (muting cycle close) some protruding objects could still occupy the light curtain and send the input to 0 (FALSE). During blind time the input remains 1 (TRUE). Blind Time can range from 250 msec to 1 second.

MUTING “T”

The MUTING operator with “T” logic performs muting of the input signal through sensor inputs S1 and S2.

➔ Preliminary condition: The Muting cycle can only start if S1 and S2 are 0 (FALSE) and the inputs are 1 (TRUE) (barrier free).

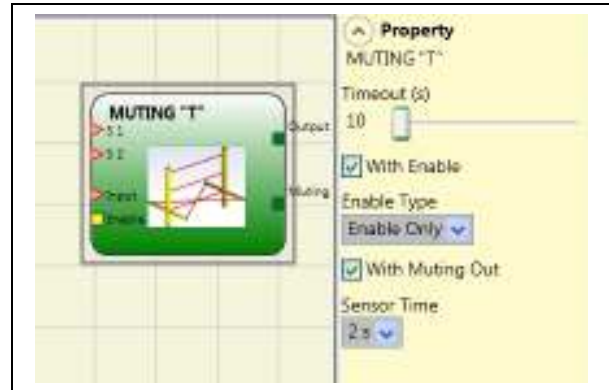

Parameters

Timeout (sec): Sets the time, between 10 secs and unlimited, within which the Muting cycle must end. If the cycle is not complete at the end of this time, Muting is immediately discontinued.

Enable: If selected it enables the possibility of enabling or not enabling the Muting function. Otherwise the Muting function is always enabled.

There are two Enable modes: Enable/Disable and Enable Only. If Enable/Disable is selected the Muting cycle cannot start if Enable is fixed at 1 (TRUE) or 0 (FALSE) but is only activated with a rising edge. To disable muting, set Enable to 0 (FALSE). In this mode the falling edge disables Muting regardless of the condition. If Enable Only is selected Muting cannot be disabled but Enable must be set to 0 (FALSE) in order to enable a new rising edge for the next Muting cycle.

Sensor time: A difference of between 2 and 5 seconds can be set for activating the sensors.

SPECIAL APPLICATIONS

Output delay with manual

If you need to have two OSSD output with one of them delayed (in MANUAL mode) use the following scheme:

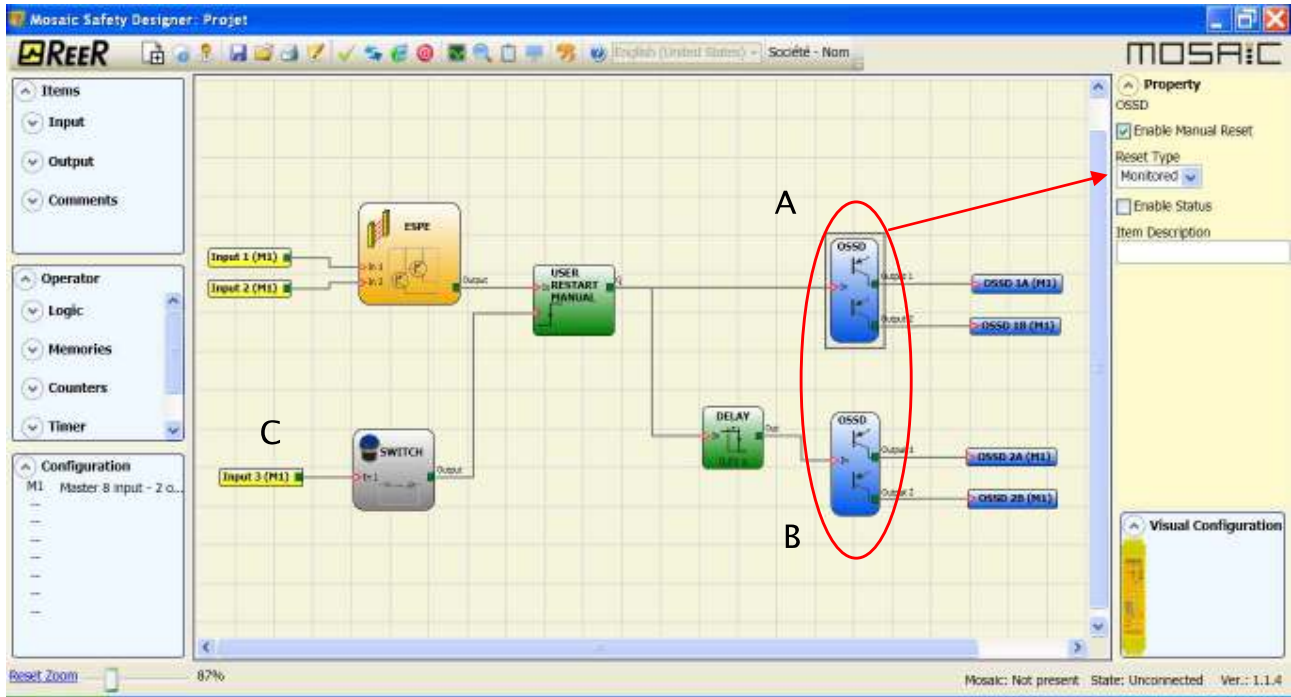

Figure 38 - Two outputs with one delayed (in MANUAL mode)

- ➔ Whereas the operating mode of the logical DELAY (see DELAY paragraph) the application must be the following:
 - The two outputs have to be programmed with RESET TYPE manual (monitored) using the function USER MANUAL RESTART.
- ➔ You must **physically** connect the button RESTART to the inputs RESTART_FBK1/2 of the OSSD A and B used (see section connections (p. 12)) and to the INPUT3 (C).

ACCESSORIES AND SPARE PARTS

MODEL	DESCRIPTION	CODE
M1	MOSAIC main unit (8 inputs / 2 double OSSD)	1100000
MI8O2	MOSAIC I/O expansion unit (8 inputs / 2 double OSSD)	1100010
MI8	MOSAIC input expansion unit (8 inputs)	1100020
MI16	MOSAIC input expansion unit (16 inputs)	1100021
MO2	MOSAIC output expansion unit (2 double OSSD)	1100030
MO4	MOSAIC output expansion unit (4 double OSSD)	1100031
MR2	MOSAIC safety relay unit (2 relays)	1100040
MR4	MOSAIC safety relay unit (4 relays)	1100041
MBP	MOSAIC PROFIBUS DP interface unit	1100050
MBD	MOSAIC DeviceNet interface unit	1100051
MBC	MOSAIC CANopen interface unit	1100052
MCM	MOSAIC external configuration memory	1100060
MSC	MOSAIC connector for 5-way communication	1100061
CSU	MOSAIC USB cable for connection to PC	1100062

WARRANTY

ReeR warrants that all of its MOSAIC units shall be free from defects in material or workmanship for a period of 12 (twelve) months from the date of shipment. This warranty applies to the products under normal conditions of use.

If the product proves to be defective during the warranty period, ReeR will repair or replace any faulty parts without any charge for material or labour.

ReeR S.p.A. may, at its discretion, replace the defective equipment with the same type of equipment or with equipment having the same characteristics, rather than repair it.

This warranty is subject to the conditions listed below:

The customer must inform ReeR of the fault within twelve months from the date of delivery of the product.

The equipment and all components must be in the condition as they were at the time of delivery by REER.

The fault or defect must not been caused either directly or indirectly by:

- Improper use;
- Failure to comply with the instructions for use;
- Carelessness, misuse, incorrect maintenance;
- Repairs, modifications, adaptations not performed by REER, tampering, etc.;
- Accidents or collisions (also during transportation and as a result of force majeure);
- Other causes for which ReeR cannot be held liable.

The defective equipment must be delivered or shipped to REER's works to be repaired: the warranty does not cover costs of transport or the risk of damage to or loss of the equipment during shipment, which shall be borne by the customer.

All products and components that are replaced become the property of REER.

ReeR shall not be held liable under any other warranties or rights except for those expressly indicated above. ReeR shall not therefore accept claims to pay damages for expenses, interruption of work or other factors or circumstances in any way related to failure of the product or any parts thereof.

Please, visit the website www.reer.it for the list of the authorised representative of each Country.

 Precise, complete compliance with all standards, instructions and warnings in this handbook is essential for the correct operation of the device. ReeR therefore declines any responsibility for all and anything resulting from failure to comply with all or some of the aforesaid instructions.

Characteristics are subject to change without prior notice. No part of this document may be reproduced unless authorised by REER.